

Catalogo 2013/2014
2013/2014 Catalogue
Catálogo 2013/2014

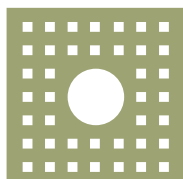

ET ERNO



LIQUID

eternoivica



eternoivica

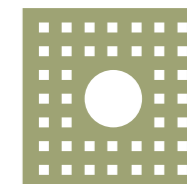
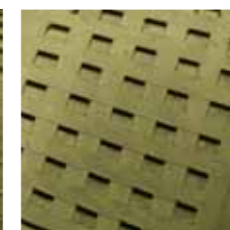
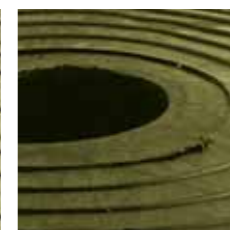

ETERNO



UNA STORIA FONDATA SULLE IMPERMEABILIZZAZIONI

A HISTORY FIRMLY-ROOTED IN THE FIELD OF WATERPROOFING
 UNA HISTORIA FUNDADA EN LAS IMPERMEABILIZACIONES

Quella di Eterno Ivica è una storia di specialisti assoluti delle impermeabilizzazioni. Tutto comincia negli anni '50 dall'esperienza di Ruggero Favero che dopo aver guidato un'azienda specializzata nella posa di membrane la IVICA (Industria Veneta Idrofughi Catrami ed Affini) fonda nel 1973 la Eterno SAS e nel 1980 nasce l'attuale ETERNO IVICA. I primi prodotti sono bocchettoni per guaine impermeabili, un campo di utilizzo che l'azienda continuerà a rivoluzionare e perfezionare. Oggi è il figlio di Ruggero, Gabriele Favero a guidare la Eterno Ivica, sempre all'avanguardia nell'evoluzione tecnica e tecnologica del settore.

The history of Eterno Ivica is one of experts operating in the field of waterproofing. It all dates back to the 1970s, when Ruggero Favero, after having gained experience with a company specializing in the installation of membranes, founded IVICA (Industria Veneta Idrofughi Catrami ed Affini). The company's first products were drain outlets for waterproof roofing felts, a range of products that the company would continue to revolutionize and perfect. The company is currently led by Ruggero's son, Gabriele Favero, who is dedicated to ensuring that Eterno Ivica will always remain at the forefront in terms of the industry's technical and technological developments.

La historia de Eterno Ivica es la de unos especialistas absolutos en impermeabilizaciones. Todo empieza en los años setenta gracias a la experiencia de Ruggero Favero que, tras dirigir una empresa especializada en la colocación de membranas, funda IVICA (Industria Veneta Idrofughi Catrami ed Affini). Los primeros productos son cazoletas para membranas impermeables, un sector que la empresa ha seguido revolucionando y perfeccionando. Hoy, es el hijo de Ruggero, Gabriele Favero, quien dirige Eterno Ivica, siempre a la vanguardia en evolución técnica y tecnológica del sector.



ACCESSORI IN MEMBRANA BITUME POLIMERO

POLYMER-BITUMEN MEMBRANE ACCESSORIES ACCESORIOS DE MEMBRANA BITUMINOSA POLIMÉRICA

Eterno Ivica dispone di una linea completa di accessori interamente costruiti in guaina bituminosa con armatura stabilizzata. Ecco quindi i bocchettoni, gli angolari, fino al profilo angolare in bi-armato. Tutti elementi progettati, realizzati e testati dagli specialisti delle coperture impermeabilizzate in MBP.

Per dare ai posatori una serie infinita di certezze.

Eterno Ivica offers a complete line of accessories made entirely from bituminous membrane with stabilized reinforcement. These include drain outlets, corner elements, and angular profiles in reinforced bituminous membrane. All the elements are designed, manufactured and tested by specialists in the field of waterproof PBM roofing.

Providing installers with endless certainties.

Eterno Ivica tienes una amplia línea de accesorios fabricados completamente con membrana bituminosa con armadura estabilizada. Entre ellos, destacan las cazoletas, los angulares o los perfiles angulares con doble armadura. Todos los elementos están proyectados, realizados y probados por especialistas en cubiertas impermeabilizadas de MBP.

Para dar a los instaladores una serie infinita de certezas.

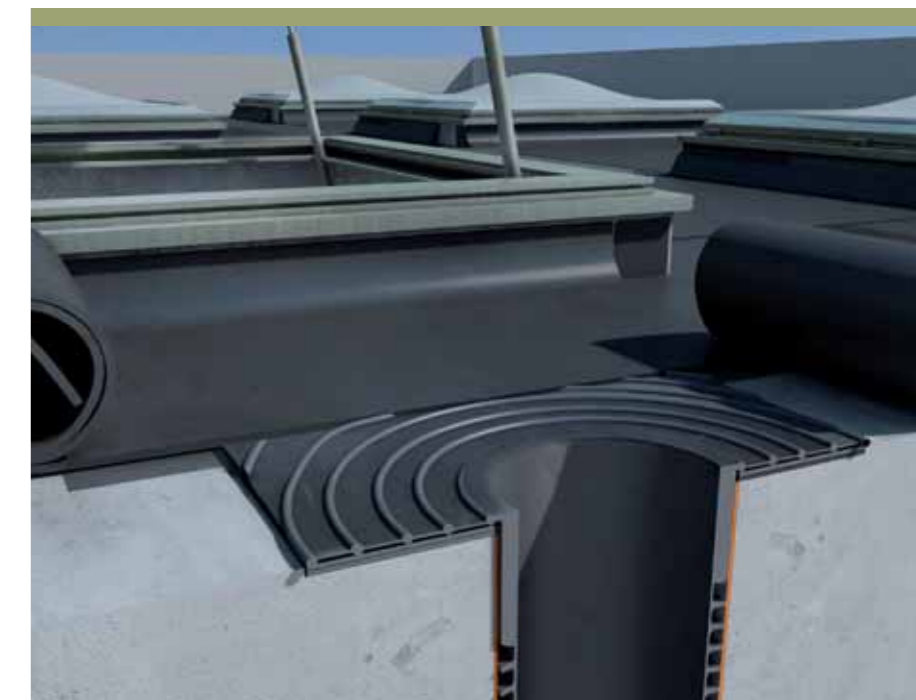

BOCCHETTONE ETERNO REVOLUTION IN MBP

**"REVOLUTION" ROOF DRAINS MADE OF
POLYMERIC BITUMINOUS MEMBRANE
CAZOLETAS "REVOLUTION"
DE MEMBRANA BITUMINOSA POLIMÉRICA**

- **Ampia gamma di misure per tubi da Ø 75 a Ø 125**
Wide range of sizes for pipes of Ø 75 to Ø 125 in diameter
Amplia gama de medidas para tubos de Ø 75 a Ø 125
- **Adattabile a qualsiasi tipo di pluviale di scarico**
Adaptable to any type of drainpipe
Adaptable a cualquier tipo de bajante de agua pluvial
- **Alta resistenza alla fiamma**
Exceptional fire resistance
Alta resistencia a la llama
- **Ampia flangia**
Wide flange
Amplio reborde



Flangia morbida e adattabile a scarichi verticali ed orizzontali
Soft flange that can be adapted to both vertical and horizontal drainpipes
Reborde suave y adaptable a desagües verticales y horizontales

Interamente stampato-termoformato, in membrana bitume-polimero armata
Totally stamped-thermoformed in reinforced polymer-bitumen membrane
Totalmente estampado-termoformado de membrana de betún-polímero armada

Predisposizione per l'inserimento di parafoglia
Predisposed for the installation of a leaf-guard
Preparado para parahojas

Ampia flangia zigrinata per maggiore adesione
Large knurled flange for improved adhesion
Amplio reborde estriado para una mayor adhesión

Raccordo rinforzato da 8 strati di armatura + MBP
Reinforced connector, comprised of 8 reinforcement layers + MBP
Rácor reforzado de 8 capas de armadura + MBP

Codolo H 250 e 450 mm
250 mm and 450 mm H shank
Manguetón H 250 y 450 mm

10 alette antiriflusso spessore 10 mm
10 backflow flaps thickness 10mm
10 alitas antirreflujo de 10 mm de espesor

VERSIONI VERSIONS VERSIONES

**BOCCHETTONE
"REVOLUTION" CON
CODOLO H 250 mm e H
450 mm**

**"REVOLUTION" ROOF
DRAIN H 250 mm AND
450 mm**

**CAZOLETA
"REVOLUTION"
H 250 mm Y 450 mm**

BOCCHETTONI "REVOLUTION" IN MEMBRANA BITUMINOSA POLIMERICA

"REVOLUTION" ROOF DRAINS MADE OF POLYMERIC BITUMINOUS MEMBRANE
CAZOLETAS "REVOLUTION" DE MEMBRANA BITUMINOSA POLIMÉRICA

Ancora una volta ETERNO IVICA rivoluziona il mondo degli accessori per le impermeabilizzazioni. La rivoluzione sta nella flangia, costituita da un fazzoletto di membrana bituminosa appositamente termoformata. La rivoluzione sta nell'adesione, assolutamente rapida e perfetta con qualsiasi membrana bituminosa, sia in mono strato sia in doppio strato. La rivoluzione sta nel codolo h 450mm e h 250mm, l'unico sul mercato con 10 alette veramente anti-reflusso per prevenire qualsiasi infiltrazione tra bocchettone e tubo di scarico. Visto lo spessore della membrana, si consiglia di fare attenzione al diametro effettivo di uscita del bocchettone.



Once again ETERNO IVICA does a revolution in the world of accessories for waterproofing systems. Revolution stays in the flange made of a piece of polymeric modified bituminous membrane. Revolution stays also in the adhesion, totally perfect and quick to any sort of bituminous membrane, both in single or double layer. Revolution stays ultimately in the spigot 450mm and 250 mm long, the one in the market with 10 real anti-infiltration tongues to prevent any infiltration between spigot and pipe in case of water back-up. Due to the thickness of the bituminous membrane, we please you pay attention to the real internal size of the drain.

Una vez más, ETERNO IVICA revoluciona el mundo de los accesorios para la impermeabilización. La revolución está en el reborde consistente en una pieza de membrana bituminosa especialmente termoformada. La revolución está en la adhesión, absolutamente rápida y perfecta con cualquier membrana bituminosa, tanto en una capa como en dos capas. La revolución está en el manguetón de 450 mm y 250 mm de altura, único en el mercado con 10 aletas verdaderamente antirretorno para evitar cualquier filtración entre el la cazoleta y el tubo de desagüe. Debido al espesor de la membrana, se ruega prestar atención al diámetro efectivo de salida de la cazoleta.

BOCCHETTONE "REVOLUTION" H 250 mm E 450 mm "REVOLUTION" ROOF DRAIN H 250 mm AND 450 mm CAZOLETA "REVOLUTION" H 250 mm Y 450 mm

Codice Code Código	Per tubi For pipes Para tubos	A	D1	D2	H		
A310250075	Ø 75	340	66	60	250	4	64
A310250082	Ø 82	340	74	67	250	4	64
A310250090	Ø 90	340	80	74	250	4	64
A310250100	Ø 100	340	93	85	250	4	64
A310250110	Ø 110	340	100	93	250	4	64
A310250125	Ø 125	340	116	106	250	4	64
A310450075	Ø 75	340	66	60	450	4	64
A310450082	Ø 82	340	74	67	450	4	64
A310450090	Ø 90	340	80	74	450	4	64
A310450100	Ø 100	340	93	85	450	4	64
A310450110	Ø 110	340	100	93	450	4	64
A310450125	Ø 125	340	116	106	450	4	64

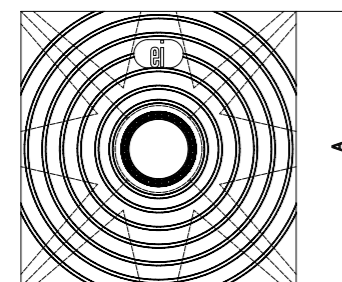
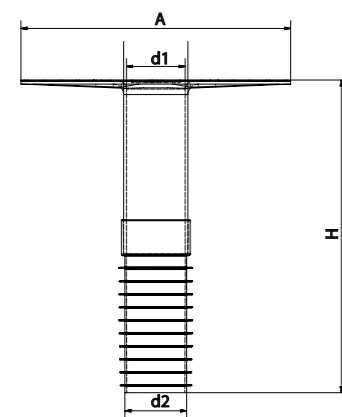

PAG. LISTINO
PAGE LIST
PÁG. LIST.

10

ANGOLI PREFABBRICATI IN MEMBRANA BITUMINOSA POLIMERICA

PREFABRICATED CORNERS MADE OF POLYMERIC BITUMINOUS MEMBRANE
ÁNGULOS PREFABRICADOS DE MEMBRANA BITUMINOSA POLIMÉRICA

Gli angoli prefabbricati bituminosi sono ottenuti dalla piegatura a caldo di un pezzo unico di membrana bituminosa con armatura composta. Il principale vantaggio è la totale fusione con la membrana bituminosa unita alla praticità e alla flessibilità di posa, dando maggiore garanzia di tenuta nei punti più a rischio di infiltrazione.

The bituminous prefabricated corners are made by hot folding of a unique piece of bituminous membrane with composite reinforcement. The main advantage is the total melting to the waterproofing sheet as long as their flexibility during installation which give a total waterproofing guarantee on the most risky points.

Los ángulos prefabricados bituminosos se obtienen doblando en caliente una pieza única de membrana bituminosa con armadura compuesta. Su principal ventaja es la fusión completa con la membrana bituminosa lo que garantiza una absoluta estanqueidad en los puntos de mayor riesgo de filtración; además, ofrece la máxima flexibilidad y facilidad de colocación.

ANGOLI BITUMINOSI INTERNI INTERNAL BITUMINOUS CORNERS ÁNGULOS BITUMINOSOS INTERNOS

Codice Code Código	Tipo Type Tipo	A	B	H		
F011004060	Angolo interno 90° Internal corner 90° Ángulo interno 90°	200	-	200	10	-

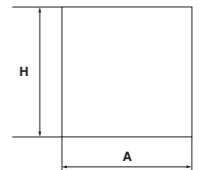

ANGOLI BITUMINOSI ESTERNI EXTERNAL BITUMINOUS CORNERS ÁNGULOS BITUMINOSOS EXTERNOS

Codice Code Código	Tipo Type Tipo	A	B	H		
F010004060	Angolo esterno 270° External corner 270° Ángulo esterno 270°	162	335	170	10	-

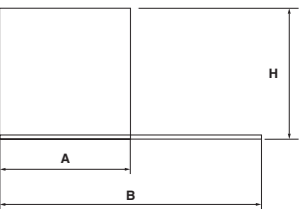

PROFILO ANGOLARE "STRIPE-BIT" "STRIPE-BIT" CANT PROFILE PERFIL ANGULAR "STRIPE-BIT"

Codice Code Código	Tipo Type Tipo	L	A	B	C		
A300454560	Stripe-Bit	1100	45	45	60	24	-

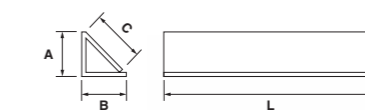

Il profilo angolare STRIPE-BIT, come per gli angoli bituminosi, è ottenuto dalla piegatura a caldo di una membrana bituminosa con armatura composta. La sua lunghezza è di 110 cm.

Like with bituminous corner profiles, the STRIPE-BIT corner profile is obtained via the hot bending of a bituminous membrane with composite reinforcement. It has a length of 110 cm.

El perfil angular STRIPE-BIT, al igual que los ángulos bituminosos, se obtiene doblando en caliente una membrana bituminosa con armadura compuesta. Su longitud es de 110 cm.



PAG. LISTINO
PAGE LIST
PÁG. LIST.

10

BOCCHETTONE ETERNO IN GOMMA EPDM

ETERNO EPDM RUBBER ROOF DRAIN CAZOLETA ETERNO DE GOMA EPDM

- Ampia gamma di misure per tubi da Ø 40 a Ø 200
Wide range of sizes for pipes of Ø 40 to Ø 200
Amplia gama de medidas para tubos de Ø 40 a Ø 200
- Adattabile a qualsiasi tipo di pluviale di scarico
Adaptable to any type of drainpipe
Adaptable a cualquier tipo de bajante de agua pluvial
- Alta resistenza alla fiamma
Exceptional fire resistance
Alta resistencia a la llama
- Ampia flangia
Wide flange
Amplio reborde



Flangia ampia e morbida, adattabile a qualsiasi forma di superficie
Soft flange that can be adapted to both vertical and horizontal drainpipes
Reborde suave y adaptable a desagües verticales y horizontales

Spigolo rinforzato
Reinforced edge
Arista reforzada

Predisposizione per l'inserimento di parafoglia
Predisposed for the installation of a leaf-guard
Preparado para parahojas

Bassorilievi a "coda di rondine" per favorire l'aggancio del bitume fuso
"Dovetail" bas-relief to facilitate the attachment of the cast bitumen
Bajorrelieves en forma de "cola de milano" para favorecer la fijación del betún fundido



Parte inferiore della flangia dotata di zigrinature
Knurled flange bottom
Parte inferior del reborde con estriado

Particolare forma del codolo studiata per aumentare l'azione "antiriflusso"
Special shank form designed to favour the "backflow prevention" effect
Manguetón de forma especial para favorecer la acción "antirreflujo"

Prolunga rigida
Rigid extension
Prolongación rígida

Parte terminale della prolunga predisposta per l'inserimento di altre prolunghe
Terminal part of the extension element predisposed for the insertion of extensions
Parte terminal de la prolongación preparada para prolongaciones

Prolunga a soffietto
Sliding extension
Prolongación de fuelle

VERSIONI VERSIONS VERSIONES

**BOCCHETTONE
IN EPDM CON CODOLO
H 200 mm e H 500 mm**
ETERNO EPDM RUBBER
ROOF DRAIN WITH A
200mm & 500 mm SPIGOT
*CAZOLETA ETERNO
DE GOMA EPDM CON
MANGUETÓN H 200 mm
Y 500 mm*

**BOCCHETTONE IN
EPDM SIFONATO**
EPDM RUBBER ROOF
DRAIN
WITH TRAP
*CAZOLETA SIFONADA
DE GOMA EPDM*

BOCCHETTONE IN GOMMA EPDM CON CODOLO H 200 mm

ETERNO EPDM RUBBER ROOF DRAIN WITH A 200 mm SPIGOT
CAZOLETA ETERNO DE GOMA EPDM CON MANGUETÓN H 200 mm

Interamente prodotto in gomma EPDM, è il primo, storico bocchettone di scarico inventato da ETERNO IVICA. Invariate nel tempo le intaccature a coda di rondine sulla flangia per una perfetta adesione alla membrana bituminosa ed il codolo cilindrico per una perfetta tenuta al pluviale di scarico.

Entirely manufactured in EPDM rubber, it is the very first historical roof drain invented by ETERNO IVICA. The exclusive dove-tail notches on the flange for a perfect bond to any bituminous membrane and the cylindrical spigot are still the same.

Realizada completamente con goma EPDM, es la primera e histórica cazoleta de desagüe inventada por ETERNO IVICA. A lo largo del tiempo, no han cambiado ni las muescas en forma de cola de milano del reborde para una perfecta adhesión a la membrana bituminosa ni tampoco el manguetón cilíndrico para una perfecta estanqueidad en el bajante del agua pluvial.



GOMMA
RUBBER

MBP



PAG. LISTINO
PAGE LIST
PAG. LIST. 11

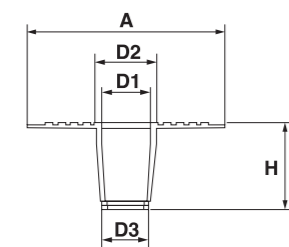
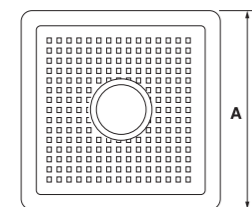

Codice Code Código	Per tubi For pipes Para tubos	A	D1	D2	D3	H	Pz	Pz
A001020040	∅ 40	250	33	39	31	175	25	1050
A001020050	∅ 50	310	45	50	42	200	25	500
A001020060	∅ 60	305	51	57	49	200	25	500
A001020075	∅ 75	340	66	72	63	200	25	400
A001020080	∅ 80	330	74	80	70	200	25	400
A001020090	∅ 90	330	80	86	78	200	25	400
A001020100	∅ 100	340	93	99	87	200	25	400
A001020110	∅ 110	340	99	105	94	200	25	400
A001020120	∅ 120	340	113	119	107	200	25	400
A001020125	∅ 125	370	116	122	113	200	20	320
A001020140	∅ 140	370	132	138	124	200	20	320
A001020150	∅ 150	390	140	146	132	200	15	240
A001020160	∅ 160	360	150	156	146	200	15	240
A001020200	∅ 200	440	189	195	179	210	10	80

BOCCHETTONE IN GOMMA EPDM SIFONATO

EPDM RUBBER ROOF DRAIN WITH TRAP
CAZOLETA SIFONADA DE GOMA EPDM

Interamente prodotto in gomma EPDM, corredato dal tradizionale codolo per l'innesto nel pluviale e dalla flangia per l'ancoraggio della membrana impermeabile, questo bocchettone è munito inoltre di una cupola per la sifonatura. Il bocchettone sifonato è venduto completo di cupola e parafoglia.

It consists of the traditional spigot that fits any kind of drain-pipe, the flange with the exclusive dove tail notches for a perfect bond to the membrane and a tank to collect the rain water. This roof drain is delivered with dome and leaf-guard.

Está formada por el tradicional manguetón para la conexión al bajante del agua pluvial y por el reborde para la fijación de la membrana impermeable así como de una cubeta para el sifonado. La cazoleta sifonada se vende con sombrerete y parafoglia.



GOMMA
RUBBER

MBP



PAG. LISTINO
PAGE LIST
PAG. LIST. 11

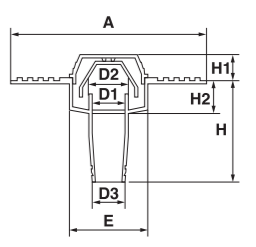
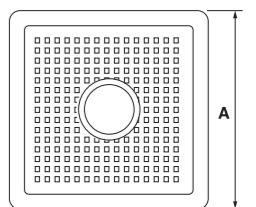

Codice Code Código	Per tubi For pipes Para tubos	A	D1	D2	D3	E	H	H1	H2	Pz	Pz
A031000080	∅ 80	393	90	97	68	170	205	55	70	5	125
A031000090	∅ 90	363	93	100	78	170	205	55	70	5	125
A031000100	∅ 100	393	90	100	87	170	205	55	70	5	125
A031000110	∅ 110	363	100	107	94	170	205	55	70	5	125

VUOI MAGGIORI INFORMAZIONI?

NEED MORE INFORMATIONS?

¿QUIERES MÁS INFORMACIÓN?

- > POSA IN OPERA ACCESSORI PER MANTI BITUMINOSI
- > INSTALLATION OF ACCESSORIES FOR BITUMINOUS MEMBRANES
- > PUESTA EN OBRA DE ACCESORIOS PARA MEMBRANAS BITUMINOSAS

ANELLI ANTIRIFLUSSO PER BOCCHETTONI IN GOMMA EPDM H 200 mm

RETRO FIT ADAPTORS FOR EPDM ROOF DRAINS H 200 mm
ANILLOS ANTIRREFLUJO PARA CAZOLETAS DE GOMA EPDM H 200 mm

GOMMA
RUBBER

PAG. LISTINO
PAGE LIST
PÁG. LIST. 11

Gli anelli antiriflusso sono stati sviluppati per adattare i bocchettone in EPDM ai tubi tipo "GEBERIT" oppure ad altre tipologie le cui misure sono espresse in pollici (inches).

The retro-fit adaptors have been specifically developed to allow the EPDM rubber roof drains to perfectly fit any kind of "GEBERIT" drain-pipes or other types of pipes whose sizes are expressed in inches.

Los anillos antirreflujo se han diseñado para adaptar las cazoletas de PDM a los tubos de tipo "GEBERIT" o bien a otros tipos de tubo cuyas medidas se expresan en pulgadas (inches).

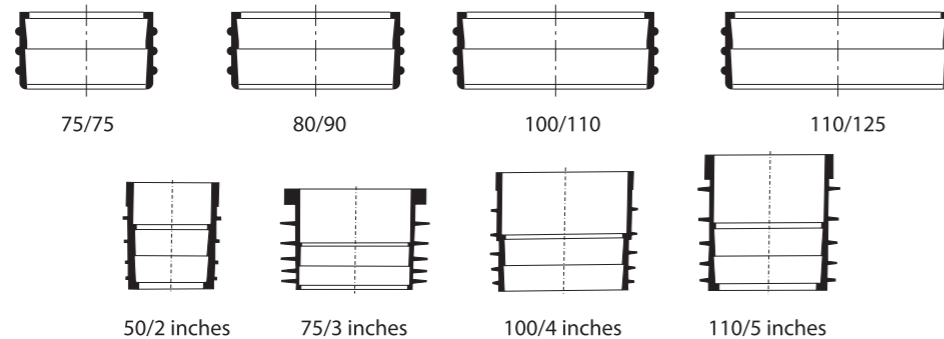

Codice Code Codigo	Misura Size Medida	Pz	Pz
F080075075	Ø 75 - 75	25	1750
F080080090	Ø 80 - 90	25	1750
F080100110	Ø 100 - 110	25	1750
F080110125	Ø 110 - 125	25	1750
F081050000	Ø 50 - 2 inches	25	1750
F081075000	Ø 75 - 3 inches	25	1750
F081100000	Ø 100 - 4 inches	25	1750
F081110000	Ø 110 - 5 inches	25	1750

PROLUNGHE PER BOCCHETTONI IN GOMMA EPDM

EXTENSIONES
PROLONGACIONES

GOMMA
RUBBER

PAG. LISTINO
PAGE LIST
PÁG. LIST. 12

Adattabile al bocchettone in gomma EPDM H mm 200 e al bocchettone sifonato. Qualora si presenti la necessità di allungare il codolo di scarico del bocchettone, esistono delle intaccature per l'applicazione di prolunghe in gomma EPDM rigide o a soffietto.

These rubber extensions are suitable to ETERNO roof drains made of EPDM rubber with a 200 mm spigot and to roof drains with trap only. If there should be any need to make the spigot longer, this range of rigid and flexible extensions is available.

Adaptable a la cazoleta de goma EPDM H mm 200 y a la cazoleta sifonada. Siempre que sea necesario alargar el manguetón de desagüe de la cazoleta, existen unas muescas para aplicar las prolongaciones de goma EPDM rígidas o de fuelle.

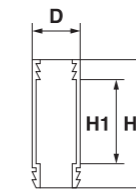

PROLUNGA IN GOMMA EPDM EPDM RUBBER EXTENSION PROLONGACIÓN DE GOMA EPDM

Codice Code Codigo	Ø	D	H	H1	Pz	Pz
B002020060	60	50	230	165	25	1750
B002020075	75	65	228	150	25	1350
B002020080	80	73	225	155	25	1050
B002020090	90	85	192	125	25	1050
B002020100	100	85	225	170	25	625
B002020110	110	95	230	170	25	625
B002020120	120	110	227	155	25	400
B002020125	125	115	245	165	20	320
B002020140	140	130	230	150	20	320
B002020150	150	140	240	155	15	240
B002020160	160	150	227	145	15	240
B002020200	200	190	237	150	10	160

PROLUNGA A SOFFIETTO IN GOMMA EPDM EPDM RUBBER FLEXIBLE EXTENSION PROLONGACIÓN DE FUELLE DE GOMA EPDM

Codice Code Codigo	Per tubi For pipes Para tubos	D	H	H1	H2	H3	Pz	Pz
B001020075	Ø 75	70	280	145	45	90	25	500
B001020080	Ø 80	75	280	145	45	90	25	500
B001020100	Ø 100	90	280	145	45	90	25	400
B001020120	Ø 120	110	280	155	40	85	25	400
B001020125	Ø 125	115	280	170	35	85	20	320

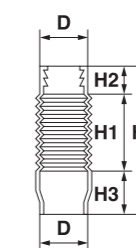

BOCCHETTONE IN GOMMA EPDM

GOMMA
RUBBER

MBP



PAG. LISTINO
PAGE LIST
PAG. LIST. 12

EPDM RUBBER ROOF DRAIN CAZOLETA DE GOMA EPDM

Questa particolare tipologia di bocchettone in EPDM è provvista di un codolo lungo 500 mm rinforzato sul fondo da un anello interno in plastica rigida. Proprio la lunghezza del codolo lo rende particolarmente adatto ad una applicazione su tetti industriali.

This particular type of EPDM roof drain has a 500 mm long spigot which is internally reinforced, at the bottom, with a rigid plastic ring. Thanks to the length of its spigot, it is specifically suitable for an installation on industrial roofs.

Este tipo especial de cazoleta de EPDM posee un manguetón de 500 mm de longitud reforzado en el fondo con un anillo interno de plástico rígido. Precisamente, gracias a la longitud del manguetón, está especialmente indicada para su aplicación en techos industriales.

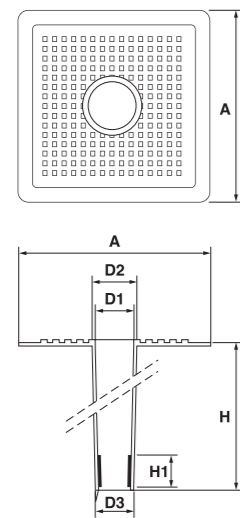

CON CODOLO H 500 mm WITH A 500 mm SPIGOT CON MANGUETÓN H 500 mm

Codice Code Codigo	Per tubi For pipes Para tubos	A	D1	D2	D3	H	H1	Pz	Pz
A021050080	ø 80	320	80	88	79	500	60	12	192
A021050100	ø 100	350	100	106	99	500	60	12	192
A021050120	ø 120	370	127	133	119	500	60	12	96
A021050150	ø 150	385	150	156	149	500	60	12	96

Una serie di bocchettoni di scarico in gomma EPDM sviluppati su apposita richiesta per applicazioni speciali.

A range of EPDM rubber roof drains specifically developed on request for special application.

Serie de cazoletas de desagüe de goma EPDM desarrolladas bajo pedido para aplicaciones especiales.

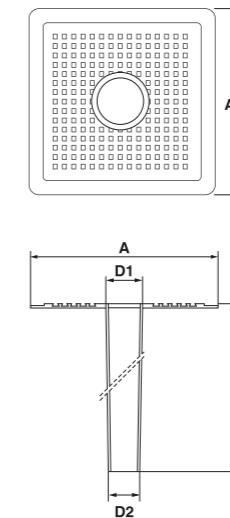

GOMMA
RUBBER

MBP



PAG. LISTINO
PAGE LIST
PAG. LIST. 13

BOCCHETTONE IN GOMMA EPDM Ø 60 mm CON CODOLO H 650 mm EPDM RUBBER ROOF DRAIN Ø 60 mm WITH A 650 mm SPIGOT CAZOLETA DE GOMA EPDM Ø 60 mm CON MANGUETÓN H 650 mm

Codice Code Codigo	Ø	A	D1	D2	H	H1	Pz	Pz
A100065060	63-75	310	62	59	650	-	20	160

BOCCHETTONE IN GOMMA EPDM Ø 140 mm CON CODOLO H 600 mm A SOFFIETTO EPDM RUBBER ROOF DRAIN Ø 140 mm WITH A 600 mm FLEXIBLE SPIGOT CAZOLETA DE GOMA EPDM Ø 140 mm CON MANGUETÓN H 600 mm DE FUELLE

Codice Code Codigo	Ø	A	D1	D2	H	H1	Pz	Pz
A110065140	140	400	140	140	600	130	1	-

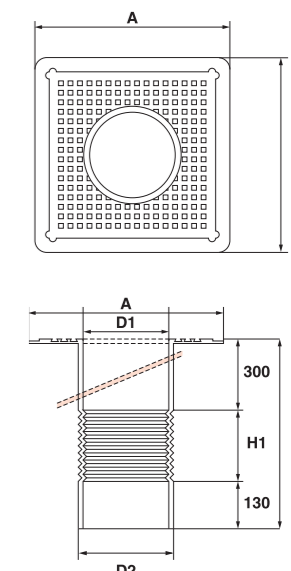

BOCCHETTONE "GENIUS" IN TPE

ROOF DRAIN "GENIUS" MADE OF TPE
CAZOLETA "GENIUS" DE TPE

- Adattabile a qualsiasi tipo di pluviale di scarico
Adaptable to any type of drainpipe
Adaptable a cualquier tipo de bajante de agua pluvial
- Ampia gamma di misure per tubi da Ø 63 a Ø 160
Wide range of sizes for pipes of Ø 63 to Ø 160
Amplia gama de medidas para tubos de Ø 63 a Ø 160
- Alta resistenza alla fiamma
Exceptional fire resistance
Alta resistencia a la llama
- Ampia flangia
Wide flange
Amplio reborde



Spigolo rinforzato
Reinforced edge
Arista reforzada

Anelli circolari "a coda di rondine" per favorire l'aggancio del bitume fuso
"Dovetail" circular rings to facilitate the attachment of the cast bitumen
Anillos circulares en forma de "cola de milano" para favorecer la fijación del betún fundido



Predisposizione per l'inserimento di parafoglia
Predisposed for the installation of a leaf-guard
Preparado para parahojas

Fori passanti per favorire la perfetta fusione della membrana superiore con quella inferiore
Through-holes to facilitate the upper membrane's perfect fusion with the lower membrane
Orificios pasantes para favorecer la perfecta fusión de la membrana superior con la inferior

Parte inferiore della flangia dotata di zigrinature
Knurled flange bottom
Parte inferior del reborde con estriado

Codolo H 250 mm e H 400 mm
250 mm H and 400 mm H shank
Manguetón H 250 mm y H 400 mm

Coppie di alette "antiriflusso" spessore 1 cm
Two 1cm thick "backflow prevention" flaps
Par de aletas antirreflujo de 1 cm de espesor

VERSIONI VERSIONS VERSIONES

**BOCCHETTONE
GENIUS IN TPE
CON CODOLO
H 250 mm e 400 mm**
ROOF DRAIN GENIUS
MADE OF TPE WITH A
250 OR 400 mm SPIGOT
*CAZOLETA GENIUS DE
TPE CON MANGUETÓN
H 250 mm Y 400 mm*

**BOCCHETTONE
EURO IN TPE CON
CODOLO
H 250 mm e 400 mm**
ROOF DRAIN EURO
MADE OF TPE WITH A
250 OR 400 mm SPIGOT
*CAZOLETA EURO DE TPE
CON MANGUETÓN H
250 mm Y 400 mm*

**BOCCHETTONE
MONDIAL IN TPE
CON CODOLO
H 170 mm e 250 mm**
ROOF DRAIN MONDIAL
MADE OF TPE WITH A
170 OR 250 mm SPIGOT
*CAZOLETA MONDIAL DE
TPE CON MANGUETÓN
H 170 mm Y 250 mm*

BOCCHETTONE "GENIUS" IN TPE CON CODOLO H 250 mm E 400 mm

ROOF DRAIN "GENIUS" MADE OF TPE WITH A 250 OR 400 mm SPIGOT
CAZOLETA "GENIUS" DE TPE CON MANGUETÓN H 250 mm Y 400 mm

Realizzato con uno speciale compound di gomma termoplastica, resistente alle basse temperature (flessibilità a freddo = -40°), è compatibile con qualsiasi membrana a base di bitume. Il bocchettone "GENIUS", unico al mondo, ha la caratteristica di avere un settore circolare della flangia dotato di fori passanti, in modo che la membrana bituminosa posta al di sopra della flangia si fonda perfettamente attraverso i fori con quella posta al di sotto. Il codolo è dotato di due o tre coppie di alette antiriflusso. Il prodotto è BREVETTATO.

Manufactured of a special compound of thermoplastic rubber, it is highly resistant against low temperatures (cold flexibility = -40°) as well as perfectly compatible with all sorts of bituminous waterproofing membrane. "GENIUS" is the only roof drain in the world with a special circular row of holes and through these holes the waterproofing membrane torched over its flange is totally blended with the membrane below. The spigot is provided with two or three couples of anti-infiltration tongues that prevent any infiltration. The product is PATENTED.

Realizada con un especial componente de goma termoplástica, resistente a las bajas temperaturas (flexibilidad en frío = -40°), es compatible con cualquier membrana bituminosa. La cazoleta "GENIUS", única en el mundo, se caracteriza por tener un sector circular del reborde dotado con orificios pasantes con lo cual la membrana bituminosa colocada encima del reborde se funde perfectamente con la membrana colocada debajo a través de los orificios. El manguetón posee dos o tres pares de aletas antirreflujo. El producto es PATENTADO.



PAG. LISTINO
PAGE LIST
PAG. LIST. 13

BOCCHETTONE H 250 mm ROOF DRAIN H 250 mm CAZOLETA H 250 mm

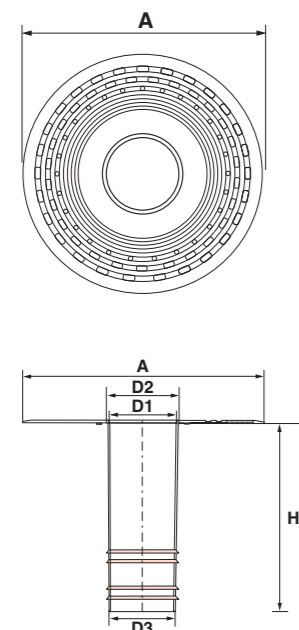

Codice Code Codigo	Per tubi For pipes Para tubos	A	D1	D2	D3	H	Pz	Pz
A017025063	Ø 63	320	51	60	49	250	25	400
A017025075	Ø 75	320	63	70	62	250	25	400
A017025082	Ø 82	320	69	75	68	250	25	400
A017025090	Ø 90	320	80	84	79	250	25	400
A017025100	Ø 100	320	86	90	85	250	25	400
A017025110	Ø 110	380	95	101	94	250	15	240
A017025125	Ø 125	380	109	115	108	250	15	240
A017025140	Ø 140	380	128	134	127	250	10	160
A017025150	Ø 150	380	134	140	132	250	10	160
A017025160	Ø 160	380	140	146	139	250	10	160



BOCCHETTONE H 400 mm ROOF DRAIN H 400 mm CAZOLETA H 400 mm

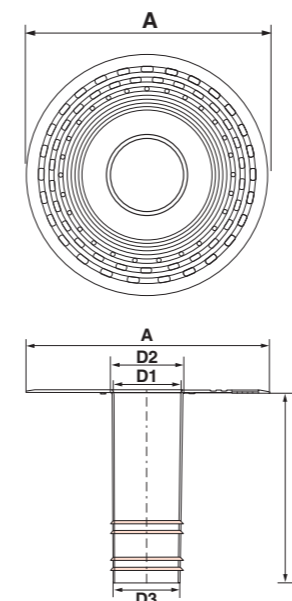

Codice Code Codigo	Per tubi For pipes Para tubos	A	D1	D2	D3	H	Pz	Pz
A017040063	Ø 63	320	51	60	49	400	15	240
A017040075	Ø 75	320	63	70	62	400	15	240
A017040082	Ø 82	320	69	75	68	400	15	240
A017040090	Ø 90	320	80	84	79	400	15	240
A017040100	Ø 100	320	86	90	85	400	15	240
A017040110	Ø 110	380	95	101	94	400	12	192
A017040125	Ø 125	380	109	115	108	400	12	96
A017040140	Ø 140	380	128	134	127	400	10	80
A017040150	Ø 150	380	134	140	132	400	10	80
A017040160	Ø 160	380	140	146	139	400	10	80



PAG. LISTINO
PAGE LIST
PAG. LIST. 13

BOCCHETTONE "EURO" IN TPE CON CODOLO H 250 mm E 400 mm

ROOF DRAIN "EURO" MADE OF TPE WITH A 250 OR 400 mm SPIGOT
CAZOLETA "EURO" DE TPE CON MANGUETÓN H 250 mm Y 400 mm

Realizzato con uno speciale compound di gomma termoplastica, resistente alle basse temperature (flessibilità a freddo = -40°), è compatibile con qualsiasi membrana a base di bitume. La flangia è dotata di canali a "coda di rondine" e di una speciale zigrinatura che garantiscono l'aggancio delle membrane bituminose. Il codolo è dotato di due o tre coppie di alette antiriflusso, a seconda che sia lungo 250 mm o 400 mm.

Manufactured of a special compound of thermoplastic rubber, it is highly resistant against low temperatures (cold flexibility = -40°) as well as perfectly compatible with all sorts of bituminous waterproofing membrane. The traditional dove-tail channels and special shagreen on the flange allow a perfect bond to the membrane. The spigot is provided with two or three couples of anti-infiltration tongues that prevent any infiltration between the spigot and the drain pipe.

Realizada con un especial componente de goma termoplástica, resistente a las bajas temperaturas (flexibilidad en frío = -40°), es compatible con cualquier membrana bituminosa. El reborde posee canales en forma de "cola de milano" y un especial estriado que garantiza la fijación de las membranas bituminosas. El manguetón posee dos o tres pares de aletas antirreflujo en función de si mide 250 mm o 400 mm de longitud.



BOCCHETTONE H 250 mm
ROOF DRAIN H 250 mm
CAZOLETA H 250 mm

Codice Code Codigo	Per tubi For pipes Para tubos	A	D1	D2	D3	H		
A013025063	Ø 63	320	51	60	49	250	25	400
A013025075	Ø 75	320	63	70	62	250	25	400
A013025082	Ø 82	320	69	75	68	250	25	400
A013025090	Ø 90	320	80	84	79	250	25	400
A013025100	Ø 100	320	86	90	85	250	25	400
A013025110	Ø 110	380	95	101	94	250	15	240
A013025125	Ø 125	380	109	115	108	250	15	240
A013025140	Ø 140	380	128	134	127	250	10	160
A013025150	Ø 150	380	134	140	132	250	10	160
A013025160	Ø 160	380	140	146	139	250	10	160

BOCCHETTONE H 400 mm
ROOF DRAIN H 400 mm
CAZOLETA H 400 mm

Codice Code Codigo	Per tubi For pipes Para tubos	A	D1	D2	D3	H		
A013040063	Ø 63	320	51	60	49	400	15	240
A013040075	Ø 75	320	63	70	62	400	15	240
A013040082	Ø 82	320	69	75	68	400	15	240
A013040090	Ø 90	320	80	84	79	400	15	240
A013040100	Ø 100	320	86	90	85	400	15	240
A013040110	Ø 110	380	95	101	94	400	12	192
A013040125	Ø 125	380	109	115	108	400	12	96
A013040140	Ø 140	380	128	134	127	400	10	80
A013040150	Ø 150	380	134	140	132	400	10	80
A013040160	Ø 160	380	140	146	139	400	10	80

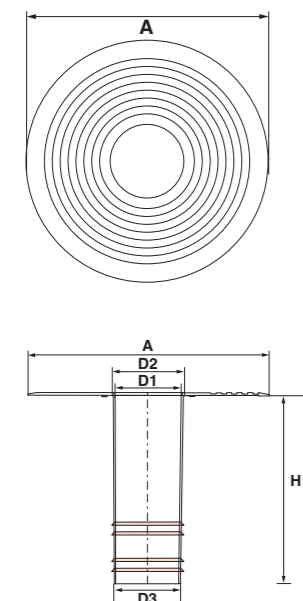

BOCCHETTONE "MONDIAL" IN TPE CON CODOLO H 170 mm E 250 mm

"MONDIAL" ROOF DRAIN MADE OF TPE WITH A 170 OR 250 MM SPIGOT
CAZOLETA "MONDIAL" DE TPE CON MANGUETÓN H 170 mm Y 250 mm

Realizzato con uno speciale compound di gomma termoplastica, resistente alle basse temperature (flessibilità a freddo = -40°), è compatibile con qualsiasi membrana a base di bitume. La flangia è dotata di canali a "coda di rondine" e di una speciale zigrinatura che garantiscono l'aggancio delle membrane bituminose.

Manufactured of a special compound of thermoplastic rubber, it is highly resistant against low temperatures (cold flexibility = -40°) as well as perfectly compatible with all sorts of bituminous waterproofing membrane. The traditional dove-tail channels and special shagreen on the flange allow a perfect bond to the membrane making the seal 100% effective.

Realizada con un especial componente de goma termoplástica, resistente a las bajas temperaturas (flexibilidad en frío = -40°), es compatible con cualquier membrana bituminosa. El reborde posee canales en forma de "cola de milano" y un especial estriado que garantiza la fijación de las membranas bituminosas.



BOCCHETTONE H 170 mm
ROOF DRAIN H 170 mm
CAZOLETA H 170 mm

Codice Code Codigo	Per tubi For pipes Para tubos	A	D1	D2	D3	H		
A010017060	Ø 60	265	52	56	49	170	25	625
A010017080	Ø 80	305	74	78	74	170	25	500
A010017100	Ø 100	335	93	97	89	170	25	400
A010017120	Ø 120	335	108	112	108	170	25	400
A010017150	Ø 150	365	137	141	137	170	10	200

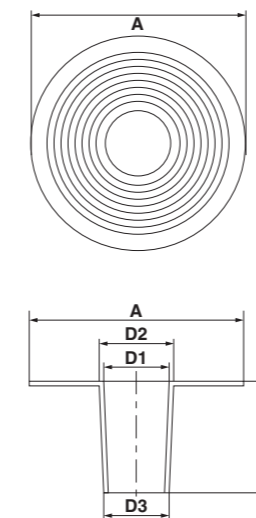

BOCCHETTONE H 250 mm
ROOF DRAIN H 250 mm
CAZOLETA H 250 mm

Codice Code Codigo	Per tubi For pipes Para tubos	A	D1	D2	D3	H		
A012025060	Ø 60	265	52	56	49	250	25	400
A012025080	Ø 80	305	74	78	74	250	25	400
A012025100	Ø 100	335	93	97	89	250	25	400
A012025120	Ø 120	335	108	112	108	250	15	240
A012025150	Ø 150	365	137	141	137	250	10	160



TPE

MBP



PAG. LISTINO
PAGE LIST
PÁG. LIST.

14

TPE

MBP



PAG. LISTINO
PAGE LIST
PÁG. LIST.

14

PAG. LISTINO
PAGE LIST
PÁG. LIST.

15

BOCCHETTONE CON SCARICO VERTICALE O LATERALE IN TPE

TPE ROOF DRAIN WITH SIDE OR VERTICAL EXIT
CAZOLETA CON DESAGÜE LATERAL O VERTICAL DE TPE

- Adattabile a qualsiasi tipo di pluviale di scarico
Adaptable to any type of drainpipe
Adaptable a cualquier tipo de bajante de agua pluvial
- Ampia gamma di misure per tubi da Ø 50 a Ø 100
Wide range of sizes for pipes of Ø 50 to Ø 100
Amplia gama de medidas para tubos de Ø 50 a Ø 100
- Alta resistenza alla fiamma
Exceptional fire resistance
Alta resistencia a la llama



Griglia in acciaio inox
Stainless steel grate
Rejilla en acero

Telaio in acciaio inox
Stainless steel frame
Marco en acero

Tappo anti-odore
Anti-odour cap
Tapón antiolor

Prolunga
Extension element
Prolongación

Scanalatura interna "acqua non stop"
"non-stop water" internal groove
Estría interna "Agua no stop"

Parte inferiore e superiore della flangia zigrinata
Top and bottom part of the knurled flange
Parte inferior y superior de la brida estriada

Flangia forata per una perfetta saldatura su qualsiasi sistema impermeabilizzante bituminoso
Flange perfectly compatible with any bituminous or resin waterproofing
Reborde perforado asegura una perfecta soldadura sobre cualquier sistema impermeabilizante bituminoso

Bocchettone verticale Ø 50 / 75 / 82 / 90 / 100
Roof drain vertical Ø 50 / 75 / 82 / 90 / 100
Cazoleta vertical Ø 50 / 75 / 82 / 90 / 100

Bocchettone orizzontale Ø 50 / 75 / 90
Roof drain side Ø 50 / 75 / 90
Cazoleta lateral Ø 50 / 75 / 90

Fondo inclinato anti-risagno d'acqua
Sloping bottom to prevent water stagnation
Fondo inclinado para evitar la acumulación del agua



BOCCHETTONE CON SCARICO LATERALE O VERTICALE IN TPE

TPE ROOF DRAIN WITH SIDE OR VERTICAL EXIT CAZOLETA CON DESAGÜE LATERAL O VERTICAL DE TPE

I bocchettone in TPE sono la soluzione ideale per balconi e terrazze: la flangia forata permette la perfetta saldatura su qualsiasi sistema impermeabilizzante bituminoso o resinoso. Il sistema è integrato da una prolunga con griglia e telaio in acciaio inox, la cui altezza può essere facilmente modificata in base allo spessore del massetto, e da uno speciale tappo anti-odore "senz'acqua". Gli elementi sono da ordinarsi separatamente.

The TPE roof drain with side and vertical exit is the ideal solution for balconies and terraces: its flange with holes is perfectly compatible with any bituminous or resin waterproofing. System is composed by an extension element that can be adjusted according to concrete screed thickness, and by a stainless steel grate plus frame. A special anti-odour cap is also available on request. Elements to be ordered separately.

Las cazoletas de TPE son la solución ideal para balcones y terrazas: el reborde perforado asegura una perfecta soldadura sobre cualquier sistema impermeabilizante bituminoso o resinoso. El sistema se completa con una prolongación con rejilla y marco de acero inoxidable cuya altura puede modificarse fácilmente en función del espesor de la capa de base y con un tapón especial antiolor "sin agua". Los elementos se han de pedir por separado.

TPE

MBP



PAG. LISTINO
PAGE LIST
PAG. LIST.

15

TAPPO ANTI-ODORE ANTI-ODOUR CAP TAPÓN ANTIOLOR

Codice Code Codigo	Per tubi For pipes Para tubos	Tappo anti-odore Anti-odour cap Tapón antiolor	A	H	D	Pz
A410010050	50	50	42,3	-	-	-
A410010075	75	75	6,6	-	-	-
A410010082	82	82	71,8	-	-	-
A410010090	90	90	80,5	-	-	-
A410010100*	100	100	89,8	-	-	-

*Da utilizzarsi con tutti i diametri orizzontali
To be used with all horizontal diameters
Para utilizar con cualquier diámetro horizontal

PROLUNGA E GRIGLIA EXTENTION AND GRATING PROLONGACIÓN Y REJILLA

Codice Code Codigo	Tipo Type Tipo	A	H	Pz
A420100078	Prolunga H 90 Extention element H 90 Prolongación H 90	99	88	1
A420100037	Prolunga H50 Extension Element H50 Prolongación H50	99	48	1
A420100018	Prolunga H18 Extension Element H18 Prolongación H18	99	17,5	1
A430100100	Griglia con telaio Grating with frame Rejilla con marco	104	5	1

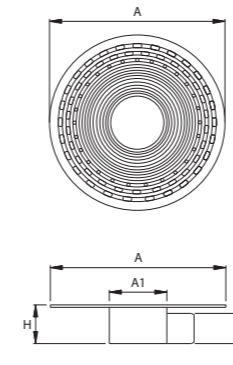
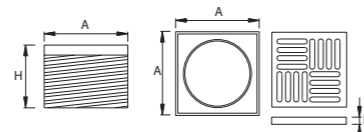
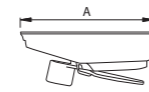

BOCCHETTONE LATERALE ROOF DRAIN SIDE CAZOLETA LATERAL

Codice Code Codigo	Per tubi For pipes Para tubos	Tappo anti-odore Anti-odour cap tapón antiolor	A	A1	H	D	Pz
A201001050	Ø 50	Ø 100	230	89,9	70	49,5	40
A201001070	Ø 75	Ø 100	230	89,9	90	73,1	40
A201001090	Ø 90	Ø 100	230	89,9	120	88,6	40

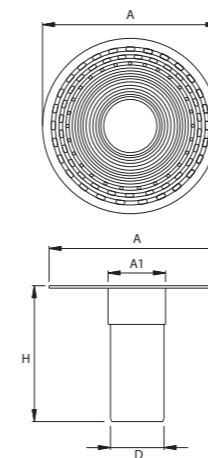

BOCCHETTONE VERTICALE ROOF DRAIN VERTICAL CAZOLETA VERTICAL

Codice Code Codigo	Per tubi For pipes Para tubos	Tappo anti-odore Anti-odour cap tapón antiolor	A	A1	H	D	Pz
A201002050	50	50	230	42,3	200	42,3	-
A201002075	75	75	230	66	200	70,3	-
A201002082	82	82	230	71,8	200	76,1	-
A201002090	90	90	230	80,5	200	84,8	-
A201002100	100	100	230	89,8	200	94,1	-



BOCCHETTONE ANGOLARE IN TPE

TPE ANGULAR DRAINS CAZOLETAS ANGULARES DE TPE

- Alta resistenza alla fiamma
Exceptional fire resistance
Alta resistencia a la llama
- Ampia flangia
Wide flange
Amplio reborde
- Disponibile in diverse sezioni e lunghezze codolo
Available in various cross-sections and shank lengths
Disponibile en diferentes secciones y longitudes del manguetón



Predisposizione per l'inserimento di "raccordo"
Predisposed for the insertion of a "connector"
Preparado para rácor

Lunghezza codolo da 370 mm a 500 mm
Shank lenght from 370 mm to 500 mm
Longitud manguetón de 370 mm a 500 mm

Spigolo rinforzato
Reinforced edge
Arista reforzada

Bassorilievi "a coda di rondine" per favorire l'aggancio del bitume fuso
"Dovetail" bas-relief to facilitate the attachment of the cast bitumen
Bajorrelieves en forma de "cola de milan" para favorecer la fijación del betún fundido

Angolo a 90° raggiato
Radiused 90° corner element
Ángulo de 90° en estrella

Predisposizione per l'inserimento di parafoglia
Predisposed for the installation of a leaf-guard
Preparado para parahojas

VERSIONI VERSIONS VERSIONES

**BOCCHETTONE
ANGOLARE ANGOLO 90°
SEZIONE TONDA
DA Ø 63 mm A Ø 125 mm**

ANGULAR DRAIN 90°
WITH ROUND SPIGOT
L 500 mm

*CAZOLETA ANGULAR 90°
CON SALIDA REDONDA
L 500 mm*

**BOCCHETTONE
ANGOLARE ANGOLO 90°
PER POGGIOLI SEZIONE
57 X 78 mm**

ANGULAR DRAIN 90°
FOR BALCONIES
57 X 78 mm SECTION

*CAZOLETA ANGULAR 90°
PARA BALCONES
SECCIÓN 57 X 48 mm*

**BOCCHETTONE
ANGOLARE ANGOLO 90°
PER POGGIOLI SEZIONE
57 X 48 mm**

ANGULAR DRAIN 90°
FOR BALCONIES
57 X 48 mm SECTION

*CAZOLETA ANGULAR 90°
PARA BALCONES
SECCIÓN 57 X 48 mm*

VERSIONI VERSIONS VERSIONES

**BOCCHETTONE
ANGOLARE
ANGOLO 45°
SEZIONE 100 X 100 mm**

ANGULAR DRAIN 45°
100 x 100 mm SECTION

*CAZOLETA
ANGULAR 45°
SECCIÓN 100 X 100 mm*

**BOCCHETTONE
ANGOLARE
ANGOLO 45°
SEZIONE 100 X 65 mm**

ANGULAR DRAIN 45°
100 x 65 mm SECTION

*CAZOLETA
ANGULAR 45°
SECCIÓN 100 X 65 mm*

**BOCCHETTONE
ANGOLARE
ANGOLO 90°
SEZIONE 100 X 65 mm**

ANGULAR DRAIN 90°
100 x 65 mm SECTION

*CAZOLETA
ANGULAR 90°
SECCIÓN 100 X 65 mm*

**BOCCHETTONE
ANGOLARE
ANGOLO 90°
SEZIONE 100 X 100 mm**

ANGULAR DRAIN 90°
100 x 100 mm SECTION

*CAZOLETA
ANGULAR 90°
SECCIÓN 100 X 100 mm*

BOCCHETTONI ANGOLARI IN TPE RACCORDI PER BOCCHETTONE ANGOLARE

TPE ANGULAR DRAINS - PIPE ADAPTORS FOR ANGULAR DRAIN
CAZOLETAS ANGULARES DE TPE - CONECTORES PARA CAZOLETAS ANGULARES

TPE

MBP

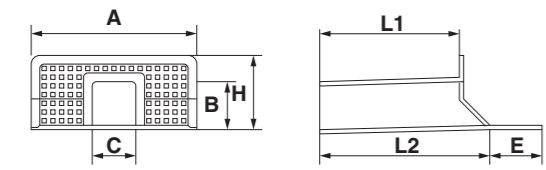

SEZIONE mm 100 X 100
100 X 100 mm SECTION
SECCIÓN mm 100 X 100

Codice Code Codigo	Tipo Type Tipo	A	B	C	E	H	L1	L2	Pz	Pz
A040415010	45°	340	92	92	105	168	375	415	5	80



PAG. LISTINO
PAGE LIST
PAG. LIST.

15

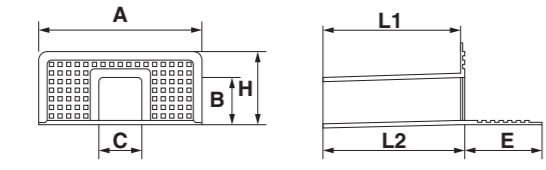

SEZIONE mm 100 X 100
100 X 100 mm SECTION
SECCIÓN mm 100 X 100

Codice Code Codigo	Tipo Type Tipo	A	B	C	E	H	L1	L2	Pz	Pz
A041375010	90°	340	92	92	145	168	375	375	5	80

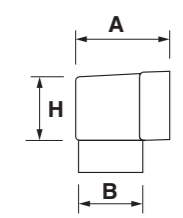

RACCORDO SEZIONE mm 100 X 100
PIPE ADAPTOR 100 X 100 mm SECTION
CONECTOR SECCIÓN mm 100 X 100

Codice Code Codigo	Tipo Type Tipo	A	B	H	Pz	Pz
F071080010	Ø 80	148	78	95	10	700
F071100010	Ø 100	148	96	96	10	700

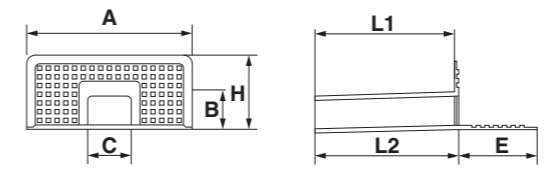

SEZIONE mm 100 X 65
100 X 65 mm SECTION
SECCIÓN mm 100 X 65

Codice Code Codigo	Tipo Type Tipo	A	B	C	E	H	L1	L2	Pz	Pz
A042425065	90°	340	62	92	145	168	425	425	10	140

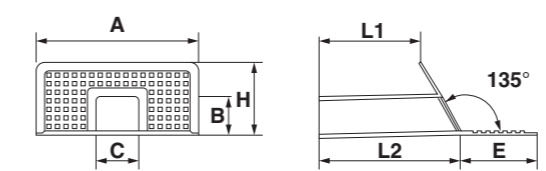

SEZIONE mm 100 X 65
100 X 65 mm SECTION
SECCIÓN mm 100 X 65

Codice Code Codigo	Tipo Type Tipo	A	B	C	E	H	L1	L2	Pz	Pz
A040425065	45°	340	62	95	145	115	370	425	10	140



TPE

MBP



PAG. LISTINO
PAGE LIST
PAG. LIST.

15

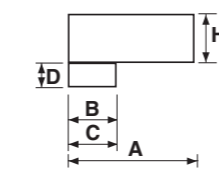

RACCORDO SEZIONE mm 100 X 65
PIPE ADAPTOR 100 X 65 mm SECTION
CONECTOR SECCIÓN mm 100 X 65

Codice Code Codigo	Misura Size Medida	A	B	C	D	H	Pz	Pz
F072063080	Ø 63 - 80	218	63	80	45	65	10	360
F072080100	Ø 80 - 100	218	80	100	62	65	10	360



BOCCHETTONE ANGOLARE IN TPE CON CODOLO TONDO L 500mm

TPE ANGULAR DRAIN WITH ROUND SPIGOT L500mm
CAZOLETA ANGULAR DE TPE CON MANGUETÓN REDONDO L500mm

Il bocchettone angolare con uscita tonda è provvisto di un codolo di scarico L.500 mm e può essere facilmente prolungato raccordandolo ad un normale tubo di plastica.

The angular roof drain with round exit spigot is provided with a 500mm long drain spigot which could be easily made longer simply by using a standard plastic pipe.

La cazoleta angular con salida redonda posee un manguetón de desagüe de 500 mm de longitud y se puede alargar fácilmente conectándolo a un tubo de plástico.

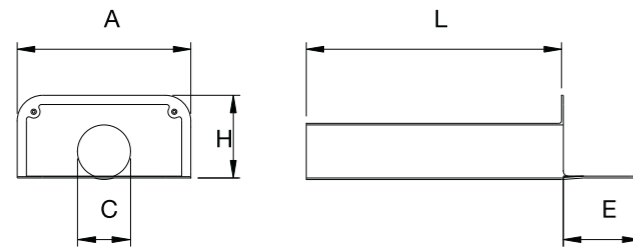

BOCCHETTONE ANGOLARE USCITA TONDA L500mm
ANGULAR DRAIN WITH ROUND SPIGOT L500mm
CAZOLETA ANGULAR CON SALIDA REDONDA L500mm

Codice Code Codigo	Per tubi For pipes Para tubos	A	C	E	H	L	Pz	Pz
A04550063	∅ 63	340	63	150	133	500	8	80
A04550075	∅ 75	340	75	150	133	500	8	80
A04550080	∅ 80	340	80	150	133	500	8	80
A04550090	∅ 90	340	90	150	165	500	8	80
A045500100	∅ 100	340	100	150	165	500	8	80
A045500110	∅ 110	340	110	150	165	500	8	80
A045500125	∅ 125	340	125	150	185	500	7	70

BOCCHETTONE ANGOLARE PER POGGIOLI

ANGULAR DRAIN FOR BALCONIES
CAZOLETA ANGULAR PARA BALCONES

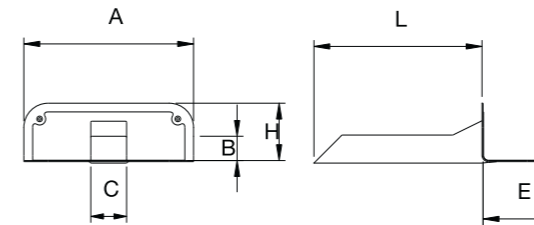

BOCCHETTONE ANGOLARE PER POGGIOLI SEZIONE 57 x 78 mm
ANGULAR DRAIN FOR BALCONIES 57 x 78 mm SECTION
CAZOLETA ANGULAR PARA BALCONES SECCIÓN mm 57 x 78

Codice Code Codigo	Colore Colour Color	A	B	C	E	H	L	Pz	Pz
A043347001	Avorio White Marfil	348	57	78	140	120	347	5	140
A043347002	Rosso Brick-red Rojo	348	57	78	140	120	347	5	140
A043347003	Rame Copper Cobre	348	57	78	140	120	347	5	140
A043347004	Nero Black Negro	348	57	78	140	120	347	5	140

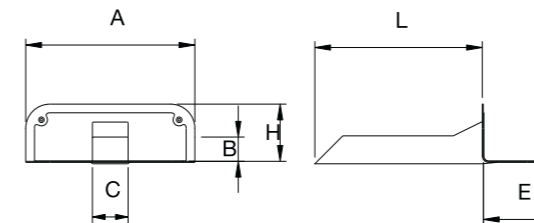

BOCCHETTONE ANGOLARE PER POGGIOLI SEZIONE 57 x 48 mm
ANGULAR DRAIN FOR BALCONIES 57 x 48 mm SECTION
CAZOLETA ANGULAR PARA BALCONES SECCIÓN mm 57 x 48

Codice Code Codigo	Colore Colour Color	A	B	C	E	H	L	Pz	Pz
A043347101	Avorio White Marfil	348	48	57	140	120	347	5	140
A043347102	Rosso Brick-red Rojo	348	48	57	140	120	347	5	140
A043347103	Rame Copper Cobre	348	48	57	140	120	347	5	140
A043347104	Nero Black Negro	348	48	57	140	120	347	5	140



ESALATORI IN TPE PER MEMBRANE IN BITUME POLIMERO

TPE ROOF VENTS FOR BITUMINOUS MEMBRANES
AIREADORES DE TPE PARA MEMBRANAS BITUMINOSAS

- Alta resistenza alla fiamma
Exceptional fire resistance
Alta resistencia a la llama
- Ampia flangia
Wide flange
Amplio reborde
- Ampia gamma di versioni
Wide range of versions
Disponibile in varias secciones y longitudes del manguetón



Cupola rinforzata
Reinforced dome
Sombbrero reforzado

Protezione circolare
Protection collar
Protección circular

Speciale zigrinatura per favorire l'aggancio del bitume fuso
Special ribbing to facilitate the attachment of the cast bitumen
Estriado especial para favorecer la fijación del betún fundido

Punti di ancoraggio per il bitume fuso
Anchoring points for the cast bitumen
Puntos de anclaje para el betún fundido

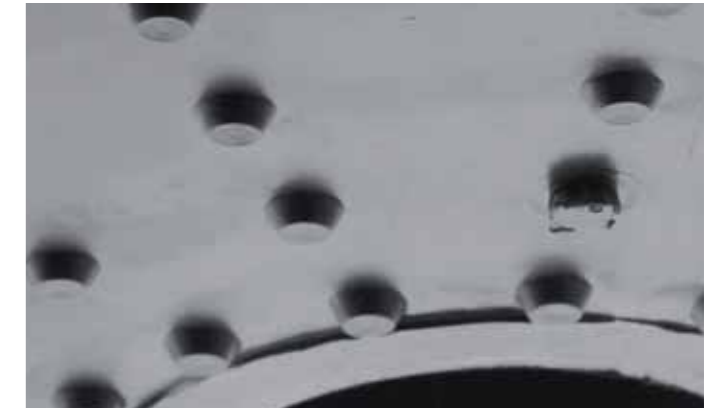

Speciali punti di appoggio in rilievo, a contatto con il piano di posa studiati per consentire il passaggio del vapore
Special embossed supporting points, in contact with the base designed to let steam pass
Puntos de apoyo especiales en relieve, en contacto con la superficie de colocación estudiados para permitir el paso del vapor

VERSIONI VERSIONS VERSIONES

ESALATORI
SEMPLICI E DOPPI DA
H 225 mm A H 400 mm
SIMPLE AND DOUBLE
WALL ROOF VENTS
H 225 TO 400 mm
*AIREADORES
SIMPLES Y DOBLES
H 225 mm A 400 mm*

ESALATORI MAXI
SEMPLICI E DOPPI
H 270 mm
SIMPLE AND DOUBLE
WALL MAXI ROOF VENTS
H 270 mm
*AIREADORES
SIMPLES Y DOBLES
H 270 mm*

ESALATORI COIBENTATI
SEMPLICI E DOPPI
H 225 mm
INSULATED SIMPLE AND
DOUBLE WALL ROOF
VENTS H 225 mm
*AIREADORES AISLADOS
SIMPLES Y DOBLES
H 225 mm*

ESALATORI IN TPE SEMPLICI E DOPPI PROTEZIONE CIRCOLARE

TPE

MBP



PAG. LISTINO
PAGE LIST
PÁG. LIST.

17

SIMPLE WALL AND DOUBLE WALL TPE ROOF VENTS - PROTECTION COLLAR AIREADORES DE TPE SIMPLÉS Y DOBLES - PROTECCIÓN CIRCULAR

La funzione dell'esalatore è permettere la fuoriuscita del vapore che si crea al di sotto della membrana impermeabile. Viene realizzato in due modelli: il tipo "semplice" che si usa in presenza della sola membrana impermeabile ed il tipo "doppio" che si usa in presenza di pannello isolante. Raccomandiamo sempre l'utilizzo dell'apposita protezione circolare.

The vent pipe allows moisture and vapour under waterproofing membrane and the double wall version used in the presence of insulating panels. For a further protection, the use of the special protection collar is also recommended.

El aireador permite la salida del vapor que se crea debajo de la membrana impermeable. Se realiza en dos modelos: el tipo "simple", que se usa cuando solo hay una membrana impermeable, y el tipo "doble", que se usa cuando hay un panel aislante. Se aconseja emplear siempre la protección circular.

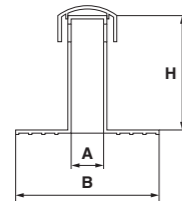

SEMPLICE H225/270mm SIMPLE WALL H225/270mm SIMPLE H225/270mm

Codice Code Codigo	Esterno External Externo	A	B	H	H1	Pz	Pz
D011225060	∅ 62	60	300	225	-	30	270
D011225075	∅ 75	72	300	225	-	25	225
D014270075	∅ 75	72	300	270	-	25	225

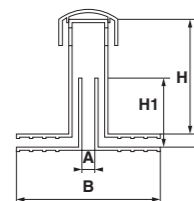

DOPPIO H225/270mm DOUBLE WALL H225/270mm DOBLE H225/270mm

Codice Code Codigo	Esterno External Externo	A	B	H	H1	Pz	Pz
D030225075	∅ 75	60	300	225	190	25	225
D030270075	∅ 75	60	300	270	190	25	225

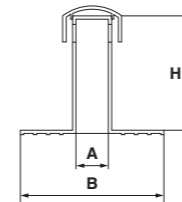

SEMPLICE H400mm SIMPLE WALL H400mm SIMPLE H400mm

Codice Code Codigo	Esterno External Externo	A	B	H	H1	Pz	Pz
D011400075	∅ 75	72	300	400	-	25	200

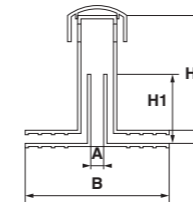

DOPPIO H400mm DOUBLE WALL H400mm DOBLE H400mm

Codice Code Codigo	Esterno External Externo	A	B	H	H1	Pz	Pz
D030400075	∅ 75	60	300	400	190	25	200

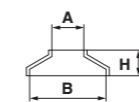

PROTEZIONE CIRCOLARE PROTECTION COLLAR PROTECCIÓN CIRCULAR

Codice Code Codigo	Esterno External Externo	A	B	H	H1	Pz	Pz
D150000000	-	75	180	60	-	25	1750



TPE

MBP



PAG. LISTINO
PAGE LIST
PÁG. LIST.

17

ESALATORE MAXI IN TPE SEMPLICE E DOPPIO

SIMPLE WALL AND DOUBLE WALL TPE MAXI ROOF VENT
AIREADOR MAXI DE TPE SIMPLE Y DOBLE

Anche l'esalatore MAXI è realizzato in due modelli: il tipo "semplice" che si usa in presenza di solo membrana impermeabile, il tipo "doppio" che si usa in presenza di un pannello isolante. Raccomandiamo sempre l'utilizzo dell'apposita protezione circolare.

The MAXI type vent pipe is also available in two different versions, the simple wall version used in case of a simple waterproofing membrane and a double wall version used in the presence of insulating boards. For a further protection, the use of the special protection collar is also recommended.

También el aireador MAXI se realiza en dos modelos: el tipo "simple", que se usa cuando solo hay una membrana impermeable, y el tipo "doble", que se usa cuando hay un panel aislante. Se aconseja emplear siempre la protección circular.

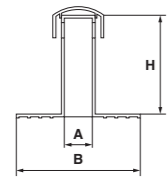

MAXI SEMPLICE H270mm
MAXI SIMPLE WALL H270mm
MAXI SIMPLE H270mm

Codice Code Codigo	Esterno External Externo	A	B	H	H1		
D015270110	Ø105	100	300	270	-	20	180

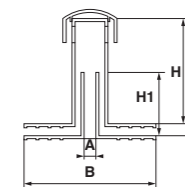

MAXI DOPPIO H270mm
MAXI DOUBLE WALL H270mm
MAXI DOBLE H270mm

Codice Code Codigo	Esterno External Externo	A	B	H	H1		
D033270110	Ø105	60	300	270	190	20	180



ESALATORE IN TPE COIBENTATO SEMPLICE E DOPPIO PROTEZIONE CIRCOLARE

INSULATED SIMPLE WALL AND DOUBLE WALL TPE ROOF VENT - PROTECTION COLLAR
AIREADOR DE TPE AISLADO SIMPLE Y DOBLE - PROTECCIÓN CIRCULAR

L'esalatore coibentato, grazie alla coibentazione in polistirolo presente nella parete esterna, elimina il rischio di condensa dovuto alla differenza di temperatura fra l'ambiente interno ed esterno. Anche l'esalatore coibentato è disponibile nei modelli "semplice" e "doppio" ed è completato dalla protezione circolare.

Thanks to the internal polystyrene insulation body, which allows the moisture to get out through the dome more easily, this type of vent pipe eliminates any risk of condensation due to the difference in temperature between the outside and the inside. Available in the "simple" and "double wall" versions with a proper protection collar.

El aireador aislado, gracias al aislamiento de poliestireno presente en su pared externa, elimina el riesgo de que se creen condensaciones debido a la diferencia de temperatura entre el ambiente interno y el externo. También el aireador aislado está disponible en los modelos "simple" y "doble" y se completa con la protección circular.

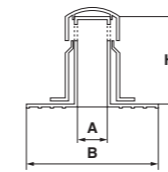

COIBENTATO SEMPLICE H225mm
INSULATED SIMPLE WALL H225mm
AISLADO SIMPLE H225mm

Codice Code Codigo	Esterno External Externo	A	B	H	H1		
D040225075	Ø105	72	300	225	-	20	180

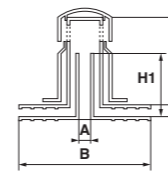

COIBENTATO DOPPIO H225mm
INSULATED DOUBLE WALL H225mm
AISLADO DOBLE H225mm

Codice Code Codigo	Esterno External Externo	A	B	H	H1		
D050225075	Ø105	60	300	225	190	20	180

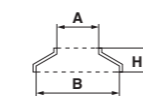

PROTEZIONE CIRCOLARE
PROTECTION COLLAR
PROTECCIÓN CIRCULAR

Codice Code Codigo	Esterno External Externo	A	B	H	H1		
D160000000	-	105	205	60	-	20	1400



PAG. LISTINO
PAGE LIST
PAG. LIST.

17



PAG. LISTINO
PAGE LIST
PAG. LIST.

17

ESALATORE "STANDARD" PER TEGOLA CANADESE

"STANDARD" TYPE AIR VENT FOR SHINGLES AIREADOR "ESTÁNDAR" PARA TEJA CANADIENSE

L'esalatore per tegola canadese "standard" è la versione più tradizionale e conosciuta di questo accessorio.

The air vent "standard" type for shingle is the most traditional and common type of this item.

El aireador para teja canadiense "estándar" es la versión más tradicional y conocida de este accesorio.

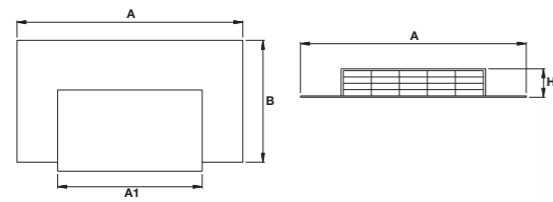

Codice Code Codigo	Tipo Type Tipo	A	B	H	H1		
D50000010	Nero Black Negro	500	267	330	60	38	-



Codice Code Codigo	Tipo Type Tipo	A	B	H	H1		
D50000020	Rosso mattone Brick-red Rojo ladrillo	500	267	300	60	38	-



Codice Code Codigo	Tipo Type Tipo	A	B	H	H1		
D50000030	Verde Green Verde	500	267	300	60	30	-

RACCORDO PER TUBI IN TPE E IN GOMMA EPDM RACCORDO CONICO IN TPE

EPDM RUBBER AND TPE BASE FITTINGS FOR PIPES - TPE CONICAL BASE FITTING FOR PIPES ESPIGONES PARA TUBOS DE TPE Y DE GOMA EPDM - ESPIGÓN CÓNICO DE TPE

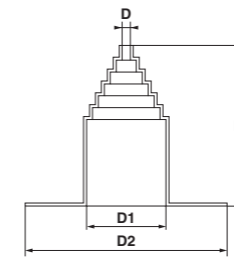

Codice Code Codigo	Tipo Type Tipo	D	D1	D2	H		
F004000000	Gomma EPDM EPDM Rubber Goma EPDM	15	130	330	250	15	240

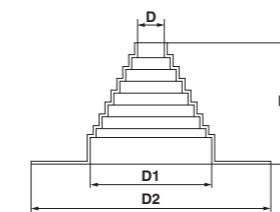

Codice Code Codigo	Tipo Type Tipo	D	D1	D2	H		
F001000000	TPE	40	175	395	190	12	360

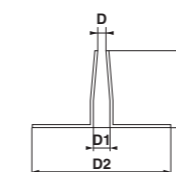

Codice Code Codigo	Tipo Type Tipo	D	D1	D2	H		
F013000000	TPE	15	30	210	120	50	2100



ANGOLI IN TPE

TPE

MBP



PAG. LISTINO
PAGE LIST
PÁG. LIST. 18

TPE CORNERS ÁNGULOS DE TPE

ANGOLO INTERNO MEDIO INTERNAL CORNER MEDIUM ÁNGULO INTERNO MEDIO

Codice Code Codigo	A	B	H	Pz	Pz
F011001100	95	-	95	200	6000*

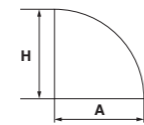

* Dimensioni pallet:
Pallet size:
Dimensiones paleta:
mm 1200 x 800 x h 1100

ANGOLO ESTERNO MEDIO EXTERNAL CORNER MEDIUM ÁNGULO ESTERNO MEDIO

Codice Code Codigo	A	B	H	Pz	Pz
F010001100	93	173	100	100	3000*

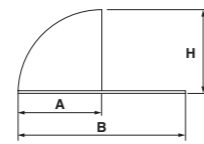

PP



PAG. LISTINO
PAGE LIST
PÁG. LIST. 18

SUPPORTO ORIENTABILE IN PP PER RETE PARAFULMINE

PP ORIENTABLE SUPPORT FOR LIGHTNING-CONDUCTOR NET SOPORTE ORIENTABLE DE PP PARA RED PARARRAYOS

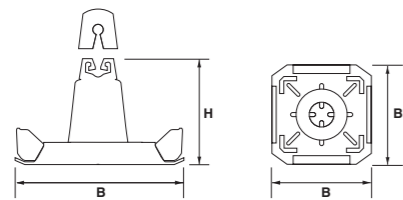

Codice Code Codigo	Tipo Type Tipo	B	H	Pz	Pz
F160000000	Supporto Support Soporte	15	10	-	-
F161000000	Cappuccio Cap Capuchón	-	-	-	-

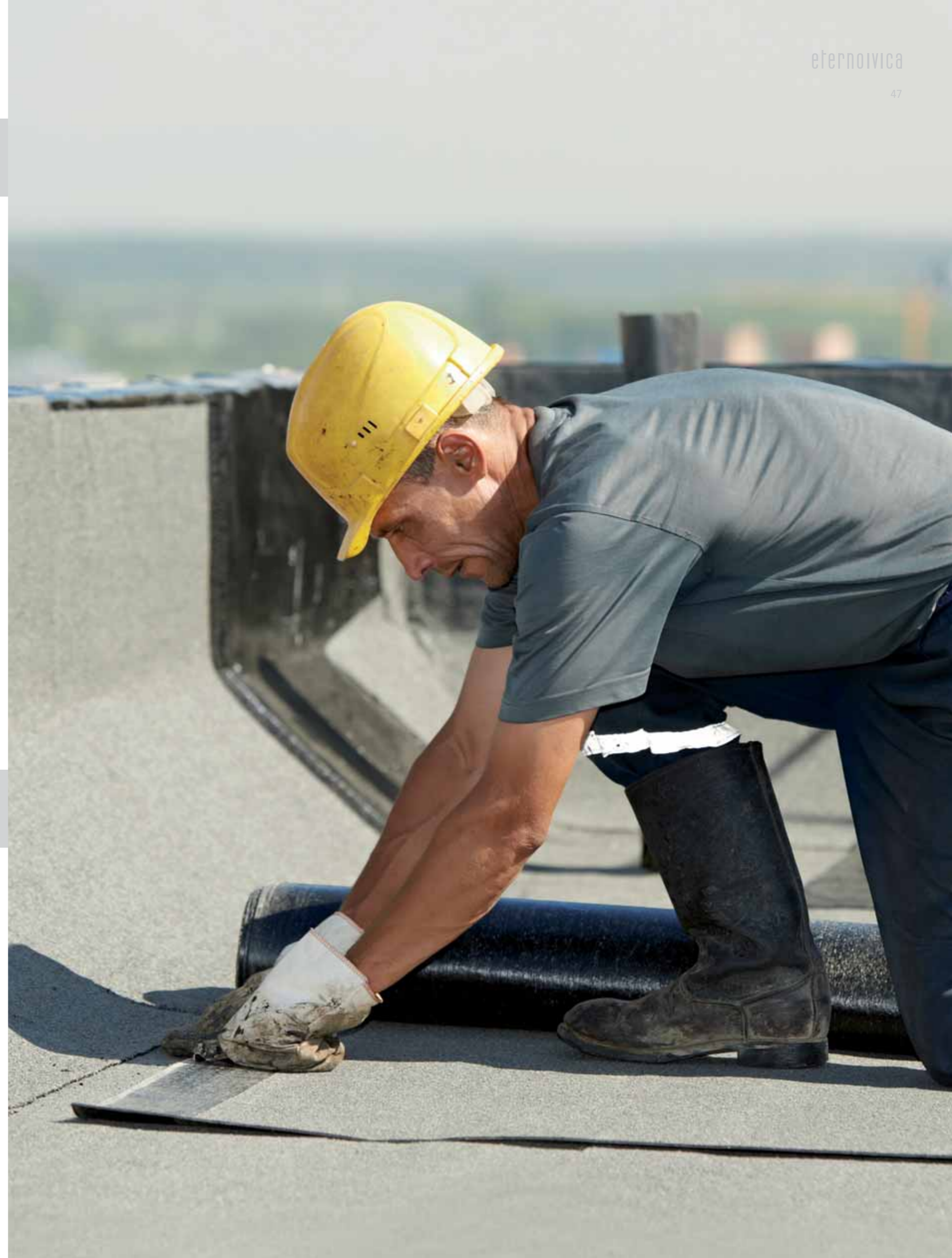

BOCCHETTONE PER MEMBRANE SINTETICHE

DRAIN HOLE FOR SYNTHETIC MEMBRANES CAZOLETAS PARA MEMBRANAS SINTÉTICAS

Una linea completa di accessori interamente costruiti in materiale sintetico che per le sue caratteristiche di efficacia, resistenza e durata sta diventando sempre più richiesto nelle impermeabilizzazioni.

Tutti elementi progettati, realizzati e testati dagli specialisti delle coperture impermeabili.

Gli accessori Eterno Ivica in materiale sintetico possono essere utilizzati in tutte le coperture piane: a tetto sia caldo sia rovescio, zavorrate e non zavorrate.

A complete line of accessories made entirely from synthetic material. Thanks to its effectiveness, strength and durability, is becoming increasingly used as a waterproofing material.

All the elements are designed, manufactured and tested by specialists in the field of waterproof roofing.

Eterno Ivica's accessories can be used for all types of flat roofing applications: whether hot, reverse, ballasted or non-ballasted.

Una amplia línea de accesorios fabricados completamente con material sintético. Por sus características de eficacia, resistencia y duración, se está convirtiendo en un material cada vez más solicitado para las impermeabilizaciones.

Los accesorios Eterno Ivica se pueden utilizar en todas las cubiertas planas: tanto calientes como invertidas, lastradas o no.

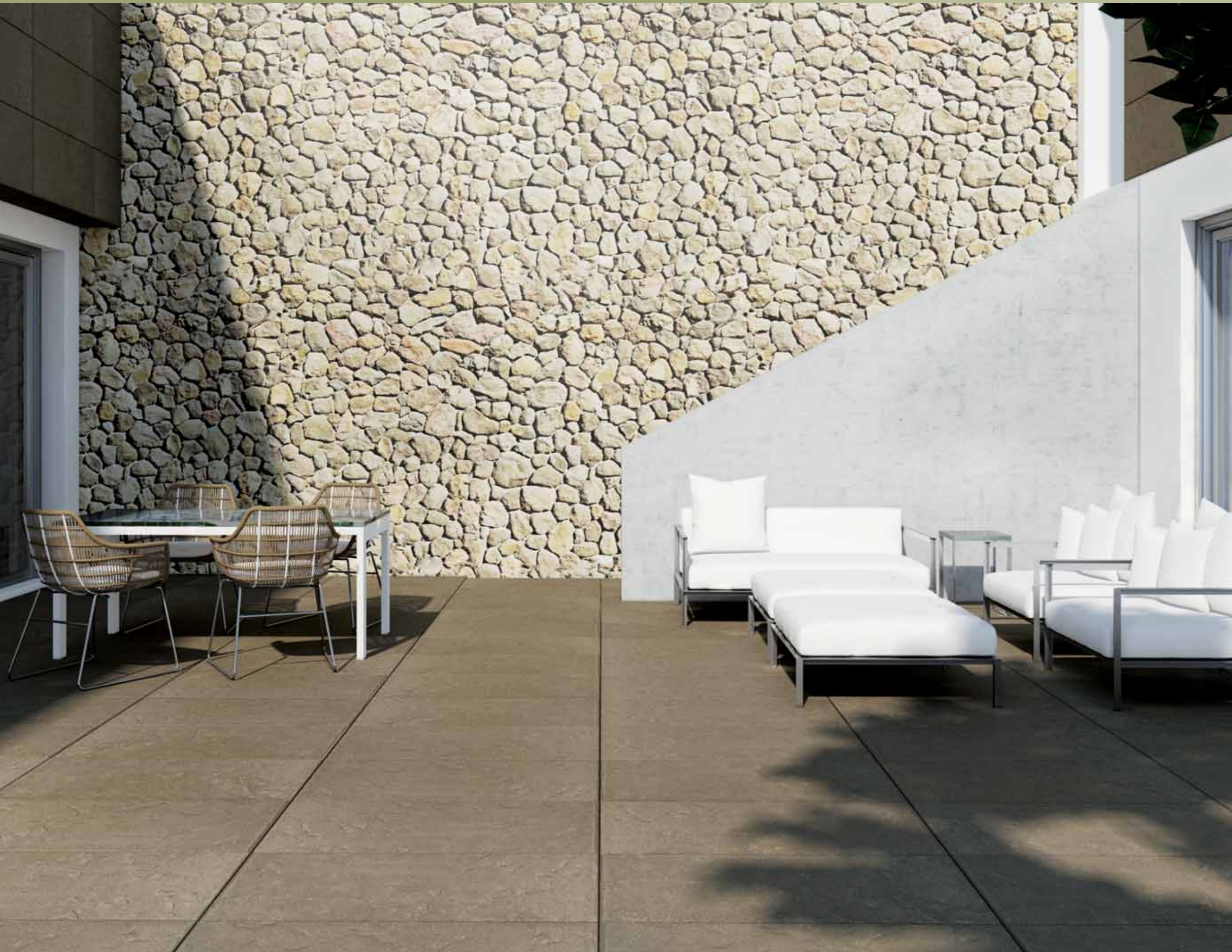

BOCCHETTONE EURO PER MEMBRANE SINTETICHE

EURO DRAIN HOLE FOR SYNTHETIC MEMBRANES
CAZOLETAS EURO PARA MEMBRANAS SINTÉTICAS

- Adattabile a qualsiasi tipo di pluviale di scarico
Adaptable to any type of drainpipe
Adaptable a cualquier tipo de bajante de agua pluvial
- Ampia flangia
Wide flange
Amplio reborde
- Ampia gamma di misure da Ø 63 mm a Ø 160 mm
Wide range of sizes, from Ø 63 mm to Ø 160 mm
Ampia gamma di misure da Ø63 mm a Ø160 mm



Predisposizione per l'inserimento di parafoglie
Predisposed for the installation of leaf-guards
Preparado para parahojas

Alta resistenza alle basse temperature
Exceptional resistance to low temperatures
Alta resistencia a las bajas temperaturas

Codolo h 250 e 400 mm
250 mm and 400 mm H shank
Manguetón H 250 y 400 mm

Coppie di speciali alette antireflusso spessore 10 mm
Two special backflow prevention flaps thickness 10 mm
Par de alitas especiales antirreflujo de 10 mm de espesor

VERSIONI VERSIONS VERSIONES

PRODOTTO IN PVC
PER MEMBRANE
SINTETICHE
IN PVC

MADE OF PVC
FOR PVC LAYERS

*FABRICADO EN PVC
PARA MEMBRANAS DE
PVC*

PRODOTTO IN TPO
PER MEMBRANE
SINTETICHE
IN TPO

MADE OF TPO
FOR TPO LAYERS

*FABRICADO EN TPO
PARA MEMBRANAS DE
TPO*

VERSIONI VERSIONS VERSIONES

PRODOTTO IN TPE
PER MEMBRANE
IN GOMMA IN EPDM

MADE OF TPE
FOR EPDM LAYERS

*FABRICADO EN TPE
PARA MEMBRANAS DE
EPDM*

PRODOTTO IN ECB
PER MEMBRANE
IN ECB E
BITUMINOSE SBS

MADE OF ECB
FOR ECB AND SBS
LAYERS

*FABRICADO EN ECB
PARA MEMBRANAS DE
ECB Y SBS*



BOCCHETTONE "EURO" IN PVC CON CODOLO H 250 mm E 400 mm

PVC ROOF DRAIN "EURO" WITH A 250 OR 400 mm SPIGOT
CAZOLETA "EURO" DE PVC CON MANGUETÓN H 250 mm Y 400 mm

Realizzati in PVC, resistenti alle basse temperature (flessibilità a freddo = -40°), sono compatibili con qualsiasi membrana impermeabile in PVC. La flangia è liscia, in modo da consentire una perfetta fusione con le membrane impermeabili. Il codolo è dotato di due o tre coppie di alette antiriflusso, a seconda che sia lungo 250 mm o 400 mm.

Manufactured of PVC, it is highly resistant against low temperatures (cold flexibility = -40°) as well as perfectly compatible with any sort of PVC membrane. The flange is totally smooth for a perfect bonding to the waterproofing sheet. According to the length of 250 or 400 mm, the spigot is provided with two or three couples of anti-infiltration rings.

Realizadas con PVC, resistentes a bajas temperaturas (flexibilidad al frío = -40°), son compatibles con cualquier membrana impermeable de PVC. El reborde es liso para permitir una perfecta fusión con las membranas impermeables. El manguetón posee dos o tres pares de aletas antirreflujo en función de si mide 250 mm o 400 mm de longitud.

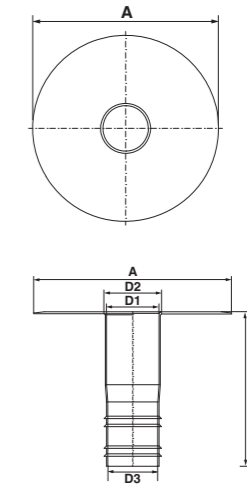

PVC

PVC

SSS



19 PAG. LISTINO
PAGE LIST
PAG. LIST.

BOCCHETTONE H 250 mm ROOF DRAIN H 250 mm CAZOLETA H 250 mm

Codice Code Codigo	Per tubi For pipes Para tubos	A	D1	D2	D3	H		
A014025063	Ø 63	320	51	60	49	250	15	240
A014025075	Ø 75	320	63	70	62	250	15	240
A014025082	Ø 82	320	69	75	68	250	15	240
A014025090	Ø 90	320	80	84	79	250	15	240
A014025100	Ø 100	320	86	90	85	250	15	240
A014025110	Ø 110	380	95	101	94	250	15	240
A014025125	Ø 125	380	109	115	108	250	15	240
A014025140	Ø 140	380	128	134	127	250	10	160
A014025150	Ø 150	380	134	140	132	250	10	160
A014025160	Ø 160	380	140	146	139	250	8	128



BOCCHETTONE H 400 mm ROOF DRAIN H 400 mm CAZOLETA H 400 mm

Codice Code Codigo	Per tubi For pipes Para tubos	A	D1	D2	D3	H		
A014040063	Ø 63	320	51	60	49	400	15	240
A014040075	Ø 75	320	63	70	62	400	15	240
A014040082	Ø 82	320	69	75	68	400	15	240
A014040090	Ø 90	320	80	84	79	400	15	240
A014040100	Ø 100	320	86	90	85	400	8	128
A014040110	Ø 110	380	95	101	94	400	8	128
A014040125	Ø 125	380	109	115	108	400	8	128
A014040140	Ø 140	380	128	134	127	400	4	64
A014040150	Ø 150	380	134	140	132	400	4	64
A014040160	Ø 160	380	140	146	139	400	4	64



BOCCHETTONI ANGOLARI IN PVC

PVC

PVC

SSS

PAG. LISTINO
PAGE LIST
PÁG. LIST. 19

PVC ANGULAR DRAINS CAZOLETAS ANGULARES DE PVC

Realizzati in PVC, sono compatibili con qualsiasi membrana impermeabile in PVC.
Manufactured of PVC, they are perfectly compatible with any sort of PVC membrane.
Realizadas con PVC, son compatibles con cualquier membrana impermeable de PVC.

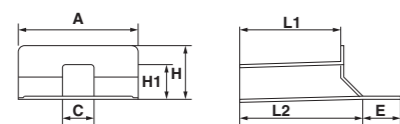

SEZIONE mm 100 X 100 100 X 100 mm SECTION SECCIÓN mm 100 X 100

Codice Code Codigo	Tipo Type Tipo	A	C	E	H1	H1	L1	L2	Pz	Pz
A060415010	45°	340	92	105	168	92	375	415	5	80

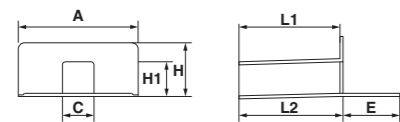

SEZIONE mm 100 X 100 100 X 100 mm SECTION SECCIÓN mm 100 X 100

Codice Code Codigo	Tipo Type Tipo	A	C	E	H1	H1	L1	L2	Pz	Pz
A061375010	90°	340	92	145	168	92	375	375	5	80

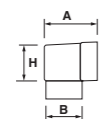

RACCORDO SEZIONE mm 100 X 100 PIPE ADAPTOR 100 X 100 mm SECTION CONECTOR SECCIÓN mm 100 X 100

Codice Code Codigo	Misura Size Medida	A	B	H	Pz	Pz
F071080010	∅ 80	148	78	95	10	700
F071100010	∅ 100	148	96	96	10	700

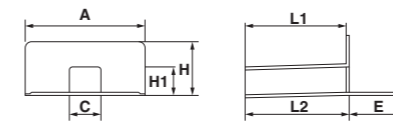

SEZIONE mm 100 X 65 100 X 65 mm SECTION SECCIÓN mm 100 X 65

Codice Code Codigo	Tipo Type Tipo	A	C	E	H1	H1	L1	L2	Pz	Pz
A062425065	90°	340	92	145	168	62	425	425	8	112

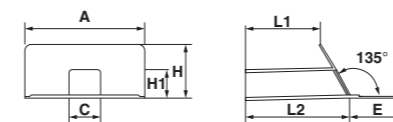

SEZIONE mm 100 X 65 100 X 65 mm SECTION SECCIÓN mm 100 X 65

Codice Code Codigo	Tipo Type Tipo	A	C	E	H1	H1	L1	L2	Pz	Pz
A060425065	45°	340	95	145	115	62	340	425	10	140

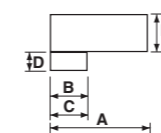

RACCORDO SEZIONE mm 100 X 65 PIPE ADAPTOR 100 X 65 mm SECTION CONECTOR SECCIÓN mm 100 X 65

Codice Code Codigo	Misura Size Medida	A	B	C	D	H	Pz	Pz
F072063080	∅ 63 - 80	218	63	80	45	65	10	360
F072080100	∅ 80 - 100	218	80	100	62	65	10	360



PVC

PVC

SSS

PAG. LISTINO
PAGE LIST
PÁG. LIST. 19

BOCCHETTONI ANGOLARI IN PVC CON CODOLO TONDO E PER POGGIOLI

PVC ANGULAR DRAIN WITH ROUND SPIGOT FOR BALCONIES CAZOLETA ANGULAR DE PVC CON MANGUETÓN REDONDO PARA BALCONES

Realizzati in PVC, resistenti alle basse temperature (flessibilità a freddo = -40°), sono compatibili con qualsiasi membrana impermeabile in PVC. La flangia è liscia, in modo da consentire una perfetta fusione con le membrane impermeabili.

Manufactured of PVC, it is highly resistant against low temperatures (cold flexibility = -40°) as well as perfectly compatible with any sort of PVC membrane. The flange is totally smooth for a perfect bonding to the waterproofing sheet.

Realizadas con PVC, resistentes a bajas temperaturas (flexibilidad al frío = -40°), son compatibles con cualquier membrana impermeable de PVC. El reborde es liso para permitir una perfecta fusión con las membranas impermeables.

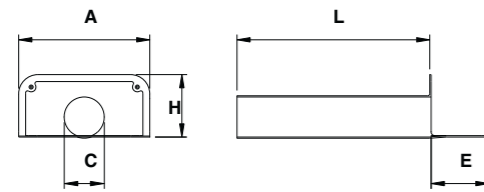

BOCCHETTONE ANGOLARE USCITA TONDA ANGULAR DRAIN WITH ROUND SPIGOT CAZOLETA ANGULAR CON SALIDA REDONDA

Codice Code Codigo	Per tubi For pipes Para tubos	A	C	E	H	L	Pz	Pz
A046500063	Ø 63	340	63	150	133	500	8	80
A046500075	Ø 75	340	75	150	133	500	8	80
A046500090	Ø 90	340	90	150	165	500	8	80
A046500110	Ø 110	340	110	150	165	500	8	80
A046500125	Ø 125	340	125	150	165	500	7	70

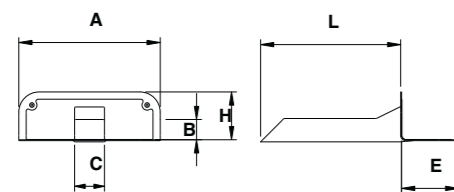

SEZIONE MM 57 X 78 57 X 78 MM SECTION SECCIÓN MM 57 X 78

Codice Code Codigo	Tipo Type Tipo	A	B	C	E	H	L	Pz	Pz
A044347000	Grigio Grey Gris	348	57	78	140	120	347	5	140

PAG. LISTINO
PAGE LIST
PÁG. LIST.

20

ESALATORI IN PVC COIBENTATO PROTEZIONE CIRCOLARE

INSULATED SIMPLE AND DOUBLE WALL ROOF VENTS - PROTECTION COLLAR AIREADORES DE PVC AISLADO - PROTECCIÓN CIRCULAR

L'esalatore coibentato, grazie alla coibentazione in polistirolo presente nella parete esterna, elimina il rischio di condensa dovuto alla differenza di temperatura fra l'ambiente interno ed esterno. Come per tutti gli altri modelli, anche l'esalatore coibentato è disponibile nei modelli "semplice" e "doppio" ed è completato dalla protezione circolare.

Thanks to the internal polystyrene insulation body, which allows the moisture to get out through the dome more easily, this type of vent pipe eliminates any risk of condensation due to the difference in temperature between the outside and the inside. As for all the other vent pipes, it is also available in the "simple" and "double wall" versions along with a proper protection collar.

El aireador aislado, gracias al aislamiento de poliestireno presente en su pared externa, elimina el riesgo de que se creen condensaciones debido a la diferencia de temperatura entre el ambiente interno y el externo. Como para los otros modelos, también el aireador aislado está disponible en los modelos "simple" y "doble" y se completa con la protección circular.

SEMPLICE SIMPLE WALL SIMPLE

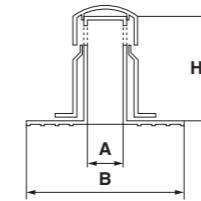

Codice Code Codigo	Ø esterno Ø external Ø externo	A	B	H	H1	Pz	Pz
D090225075	107	72	300	225	-	20	180



DOPPIO DOUBLE DOBLE

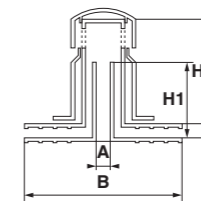

Codice Code Codigo	Ø esterno Ø external Ø externo	A	B	H	H1	H2	Pz	Pz
D100225075	107	60	300	225	190	20	180	



PROTEZIONE CIRCOLARE PROTECTION COLLAR PROTECCIÓN CIRCULAR

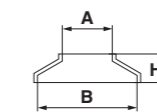

Codice Code Codigo	Ø esterno Ø external Ø externo	A	B	H	H1	Pz	Pz
D160000000	-	105	205	60	-	20	1400



PAG. LISTINO
PAGE LIST
PÁG. LIST.

20

ESALATORI IN PVC SEMPLICI E DOPPI PROTEZIONE CIRCOLARE

PVC

PVC

SSS

SIMPLE WALL AND DOUBLE WALL PVC ROOF VENTS - PROTECTION COLLAR AIREADORES DE PVC SIMPLES Y DOBLES- PROTECCIÓN CIRCULAR

Perfettamente compatibile con qualsiasi membrana impermeabile in PVC è realizzato in due modelli, il tipo "semplice", che si usa solo in presenza di membrana impermeabile, il tipo "doppio" che si usa nel caso venga applicato un pannello isolante. Raccomandiamo l'uso dell'apposita protezione circolare.

Perfectly compatible with all sorts of PVC membrane, it's available in the following models: the simple wall version used in case of a simple waterproofing membrane and the double wall version used in the presence of insulating panels. For a further protection, a specific collar is also provided.

Absolutamente compatibile con cualquier membrana impermeable de PVC, se realiza en dos modelos: el tipo "simple", que se usa cuando solo hay una membrana impermeable, y el tipo "doble", que se usa cuando se aplica un panel aislante. Se aconseja emplear siempre la correspondiente protección circular.

PAG. LISTINO
PAGE LIST
PAG. LIST. 21

SEMPLICE SIMPLE WALL SIMPLE

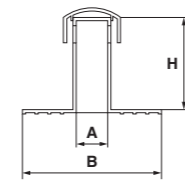

Codice Code Codigo	Ø esterno Ø external Ø externo	A	B	H	H1		
D070225075	75	72	300	225	-	20	180

DOPPIO DOUBLE DOBLE

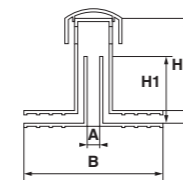

Codice Code Codigo	Ø esterno Ø external Ø externo	A	B	H	H1		
D080225075	75	60	300	225	190	20	180

PROTEZIONE CIRCOLARE PROTECTION COLLAR PROTECCIÓN CIRCULAR

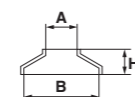

Codice Code Codigo	Tipo Type Tipo	Ø esterno Ø external Ø externo	A	B	H	H1		
D150000000	Protezione circolare Ø 75 mm Protection collar Ø 75 mm Protección circular Ø 75 mm	-	75	180	60	-	25	1750
D160000000	Protezione circolare Ø 110 mm Protection collar Ø 110 mm Protección circular Ø 110 mm	-	105	205	60	-	20	1400

PVC

PVC

SSS

PAG. LISTINO
PAGE LIST
PAG. LIST. 21

SEMPLICE SIMPLE WALL SIMPLE

Codice Code Codigo	Ø esterno Ø external Ø externo	A	B	H	H1		
D070400075	75	72	300	400	-	12	96

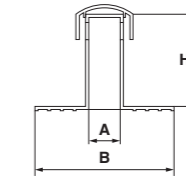

DOPPIO DOUBLE DOBLE

Codice Code Codigo	Ø esterno Ø external Ø externo	A	B	H	H1		
D080400075	75	60	300	400	190	12	96

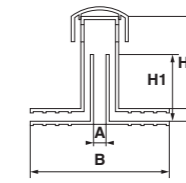

MAXI SEMPLICE MAXI SIMPLE WALL MAXI SIMPLE

Codice Code Codigo	Ø esterno Ø external Ø externo	A	B	H	H1		
D070270110	105	100	300	270	-	15	135

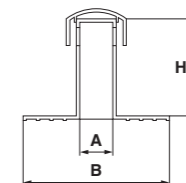

MAXI DOPPIO MAXI DOUBLE MAXI DOBLE

Codice Code Codigo	Ø esterno Ø external Ø externo	A	B	H	H1		
D101270110	105	60	300	270	190	15	135

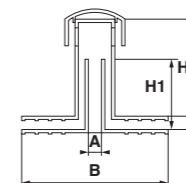

ANGOLI INTERNI ED ESTERNI IN PVC

PVC

PVC

SSS

PAG. LISTINO
PAGE LIST
PAG. LIST. 21



PVC INTERNAL AND EXTERNAL CORNER ÁNGULOS INTERNOS Y EXTERNOS DE PVC

Gli angoli interni ed esterni in PVC sono elementi estremamente importanti e necessari al completamento di una impermeabilizzazione con membrane monostrato in PVC. Servono infatti a proteggere e rinforzare gli spigoli e gli angoli presenti nella copertura da impermeabilizzare per esempio in presenza di muri e lucernari. La gamma Eterno si compone di 3 distinti modelli diversi tra loro per dimensioni. I modelli MINI con una altezza di 70mm, sono la soluzione più economica della gamma. Il modello MEDIO ha un' altezza di 95mm. È questo il modello sicuramente più venduto. L'esclusiva versione MAXI è infine un modello unico per ampiezza di dimensioni con un'altezza di ben 150mm per offrire una superficie impermeabilizzante davvero fuori standard.

PVC internal and external corners are element of a high importance and needed to finish a waterproofing with single-ply PVC membranes. The main purpose of these items is to protect and reinforce the waterproofing sheet on corners and edges (internal and external corners) like for example in presence of walls and skylights. The Eterno range offers 3 different types of corners with different sizes. Brand MINI type is only 70mm high and is the cheaper version in the range. The MEDIUM version is 95mm height. This is for sure the most popular and used type. Thanks to its large surface (150mm high), the exclusive MAXI type is ultimately a unique version that offers a very wide waterproofing area.



Los ángulos internos y externos de PVC son unos elementos muy importantes y necesarios para completar las impermeabilizaciones con membranas de una capa de PVC. En efecto, sirven para proteger y reforzar las esquinas y los ángulos presentes en el techo que se debe impermeabilizar, por ejemplo, cuando hay paredes y claraboyas. La gama Eterno se compone de tres modelos que se diferencian por sus dimensiones. Los modelos MINI con una altura de 70 mm son la solución más económica de la gama. El modelo MEDIO hay una altura de 95 mm. Seguramente, este es el modelo más vendido. La exclusiva versión MAXI es un modelo único por sus dimensiones con una altura de 150 mm para ofrecer una superficie impermeabilizante fuera de lo estándar.

ANGOLO INTERNO MINI INTERNAL CORNER MINI ÁNGULO INTERNO MINI

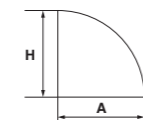
Codice Code Codigo	A	B	H		
F011000200	70	-	70	350	-



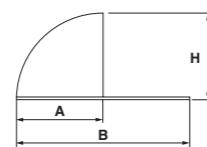

ANGOLO ESTERNO MINI EXTERNAL CORNER MINI ÁNGULO ESTERNO MINI

Codice Code Codigo	A	B	H		
F010000200	67	128	70	200	-



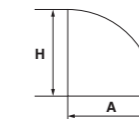

ANGOLO INTERNO MEDIO INTERNAL CORNER MEDIUM ÁNGULO INTERNO MEDIO

Codice Code Codigo	A	B	H		
F011000100	95	-	95	200	6000+



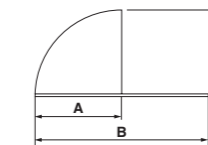

ANGOLO ESTERNO MEDIO EXTERNAL CORNER MEDIUM ÁNGULO ESTERNO MEDIO

Codice Code Codigo	A	B	H		
F010000100	93	173	100	100	3000+



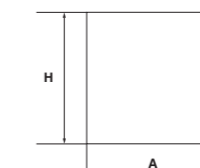

ANGOLO INTERNO MAXI INTERNAL CORNER MAXI ÁNGULO INTERNO MAXI

Codice Code Codigo	A	B	H		
F011000030	150	-	150	80	1600+



ANGOLO ESTERNO MAXI EXTERNAL CORNER MAXI ÁNGULO ESTERNO MAXI

Codice Code Codigo	A	B	H		
F010000030	150	300	150	40	800*

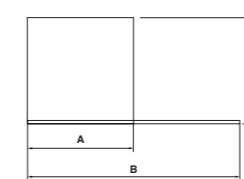

* Dimensioni pallet Pallet size Dimensiones paleta mm 1200 x 800 x h 1100

PVC

PVC

SSS

PAG. LISTINO
PAGE LIST
PAG. LIST. 21

RACCORDI IN PVC

PVC

PVC

SSS

PAG. LISTINO
PAGE LIST
PÁG. LIST. 21

PVC BASE FITTING ESPIGÓN PARA TUBOS DE PVC

I raccordi vengono applicati nei casi in cui fuoriescano dei tubi di sfiato dal solaio di copertura. L'applicazione è molto semplice: basta tagliare in corrispondenza della sezione richiesta, inserirlo all'esterno del tubo e sigillare mediante fascetta metallica stringitubo.

The fittings should be applied in cases where the vent pipes come out of the roofing floor. Application is very easy: simply cut according to the section required, slip it on the pipe and seal using a metal pipe clamp.

Los racores se aplican cuando sobresalen tubos de desahogo a través de la capa de recubrimiento. El montaje es muy fácil: solo hay que cortar el racor según la sección deseada, introducirlo en el exterior del tubo y sellar la unión mediante una abrazadera metálica.

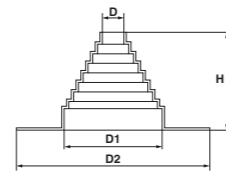

RACCORDO PER TUBI IN PVC PVC BASE FITTING FOR PIPES ESPIGÓN PARA TUBOS DE PVC

Codice Code Codigo	D	D1	D2	H		
F002000000	40	175	395	190	12	360

RACCORDO CONICO IN PVC PVC CONICAL BASE FITTING FOR PIPES ESPIGÓN CÓNICO DE PVC

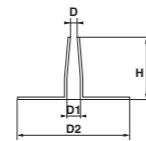

Codice Code Codigo	D	D1	D2	H		
F012000000	15	30	210	120	50	2100

BOCCHETTA PVC PROVA PRESSIONE

PVC PRESSURE TEST ELEMENT CAZOLETA DE PVC DE PRUEBA DE PRESIÓN

La bocchetta PVC prova pressione è un elemento indispensabile per il collaudo delle saldature a "doppia pista" delle membrane sintetiche in PVC.

The PVC pressure test element is a new and essential item to test the pressure seal in the "double lane" overlaps made with pvc synthetic sheets.

La cazoleta de PVC de prueba de presión es un elemento indispensable para probar las soldaduras de "doble pista" de las membranas sintéticas de PVC.

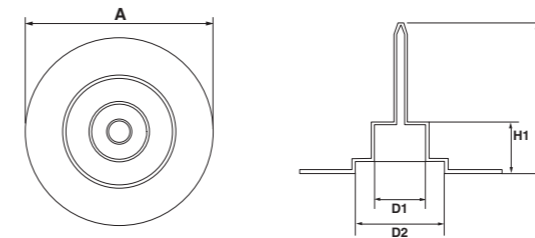

Codice Code Codigo	A	D1	D2	H	H1		
F100000000	177	30	73	40	65	100	2000

PVC

PVC

SSS

PAG. LISTINO
PAGE LIST
PÁG. LIST. 22

PROFILI PERIMETRALI PER MEMBRANE IN PVC

PROFILES FOR PVC MEMBRANES PERFILES PERIMÉTRICOS PARA MEMBRANAS DE PVC

I profili perimetrali sono compatibili con qualsiasi membrana impermeabile in PVC. Sono realizzati in lamiera zincata accoppiata a PVC.

This kind of profile is perfectly compatible to any kind of PVC waterproofing membrane. It is manufactured with galvanized-plate combined to PVC.

Los perfiles perimétricos son compatibles con cualquier membrana impermeable de PVC. Se realizan con chapa cincada combinada con PVC.



Profilo a parete
sviluppo 70 mm - lunghezza 2 mt
Perimetral wall profile
height 70 mm - length 2 mt
Perfil de pared
desarrollo mm 70 - longitud m 2

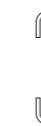

Piattina di fissaggio
sviluppo 50 mm - lunghezza 2 mt
Fixing flat element
height 50 mm - length 2 mt
Pletina de fijación
desarrollo mm 50 - longitud m 2

Codice Code Codigo	Tipo Type Tipo		
F041007002	70 mm	2	-
F040005002	50 mm	2	-



PVC

PVC

SSS

PAG. LISTINO
PAGE LIST
PÁG. LIST. 22

ACCESSORI PER MANTI IMPERMEABILI IN POLIOLEFINE (TPO)

ACCESSORIES FOR TPO LAYERS ACCESORIOS PARA MEMBRANAS IMPERMEABLES DE TPO

Per le sue caratteristiche di efficacia, resistenza e durata, il Poliolefina TPO sta diventando un materiale sempre più richiesto nelle impermeabilizzazioni.

Eterno Ivica produce accessori specifici per guaine sintetiche sin dall'apparire sul mercato di questa tipologia di materiali: ecco perché ha acquisito un'esperienza tecnica insuperabile. Gli accessori Eterno Ivica in TPO possono essere utilizzati in tutte le coperture piane: a tetto sia caldo sia rovescio, zavorrate e non zavorrate.

Thanks to its effectiveness, strength and durability, Thermoplastic PolyOlefin (TPO) is becoming increasingly used as a waterproofing material.

Eterno Ivica has been manufacturing specific accessories for synthetic roofing felts since these types of materials appeared on the market, and has thus succeeded in acquiring unrivalled technical expertise.

Eterno Ivica's TPO accessories can be used for all types of flat roofing applications: whether hot, reverse, ballasted or non-ballasted.

Por sus características de eficacia, resistencia y duración, la poliolefina (TPO) se está convirtiendo en un material cada vez más solicitado para las impermeabilizaciones.

Eterno Ivica fabrica accesorios específicos para membranas sintéticas desde que este tipo de material apareció en el mercado: por ello, su experiencia técnica es insuperable.

Los accesorios Eterno Ivica de TPO se pueden utilizar en todas las cubiertas planas: tanto calientes como invertidas, lastradas o no.

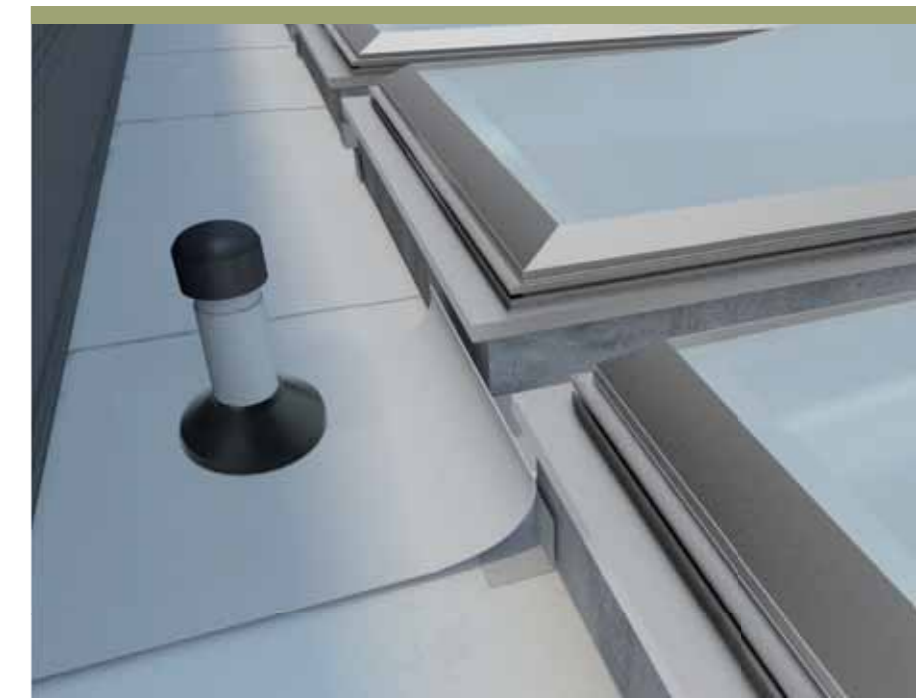

BOCCHETTONE "EURO" IN POLIOLEFINE (TPO) CON CODOLO H 250 mm

ROOF DRAIN "EURO" MADE OF POLYOLEFYNE (TPO) WITH A 250 mm H SPIGOT
CAZOLETA "EURO" DE POLIOLEFINA (TPO) CON MANGUETÓN H 250 mm

Realizzati in Poliolefine universale di colore bianco, sono creati per garantire la massima compatibilità con qualsiasi membrana in Poliolefine. La flangia è liscia per consentire una perfetta fusione con le membrane impermeabili. Il codolo è dotato di due coppie di alette antiriflusso.

Manufactured of universal Polyolefine white, they are made to guarantee a perfect compatibility to any sort of TPO waterproofing membrane. The flange is totally smooth for a perfect bonding to the waterproofing membrane. The spigot is provided with two couples of anti-infiltration tongues.

Realizadas con Poliolefina universal de color blanco, se han creado para garantizar la máxima compatibilidad con cualquier membrana de poliolefina. El reborde es liso para permitir una perfecta fusión con las membranas impermeables. El manguetón posee dos pares de aletas antirreflujo.

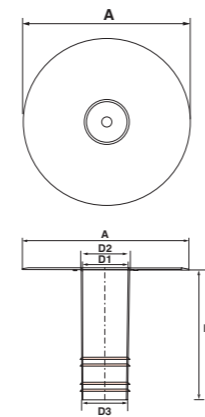

Codice Code Codigo HIFAX	Codice Code Codigo ADFLEX*	Ø esterno Ø external Ø externo	A	D1	D2	D3	H		
A015225063	A015025063	63	320	51	60	49	250	15	240
A015225075	A015025075	75	320	63	70	62	250	15	240
A015225082	A015025082	82	320	69	75	68	250	15	240
A015225090	A015025090	90	320	80	84	79	250	15	240
A015225100	A015025100	100	320	86	90	85	250	15	240
A015225110	A015025110	110	380	95	101	94	250	15	240
A015225125	A015025125	125	380	109	115	108	250	15	240
A015225140	A015025140	140	380	128	134	127	250	10	160
A015225150	A015025150	150	380	134	140	132	250	10	160
A015225160	A015025160	160	380	140	146	139	250	10	160

* Prodotto ADFLEX a richiesta ADFLEX type on request Producto ADFLEX bajo pedido

TPO

TPO

SSS

PAG. LISTINO
PAGE LIST
PÁG. LIST. 22

BOCCHETTONE ANGOLARE 90° - L 425 mm IN POLIOLEFINE (TPO)

ANGULAR DRAIN 90° - L 425 mm MADE OF POLYOLEFYNE (TPO)
CAZOLETA ANGULAR DE 90° - L 425 mm DE POLIOLEFINA (TPO)

Realizzato in Poliolefine universale di colore bianco, è creato per garantire la massima compatibilità con qualsiasi membrana in Poliolefine. È dotato di raccordi per i tubi di scarico, vedi pagina 52-53.

Manufactured of universal Polyolefine white, they are made to guarantee a perfect compatibility to any sort of TPO waterproofing membrane. See on pages 52-53 for pipe adaptors.

Realizada con Poliolefina universal de color blanco, se ha creado para garantizar la máxima compatibilidad con cualquier membrana de poliolefina. Posee conectores para los tubos de desagüe (véase páginas 52-53).

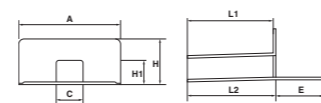

Codice Code Codigo HIFAX	Codice Code Codigo ADFLEX*	Tipo Type Tipo	A	C	E	H	H1	L1	L2		
A042425265	A042425165	90°	340	92	145	168	62	425	425	8	112

* Prodotto ADFLEX a richiesta ADFLEX type on request Producto ADFLEX bajo pedido

TPO

TPO

SSS

PAG. LISTINO
PAGE LIST
PÁG. LIST. 23

ESALATORE IN POLIOLEFINE (TPO) SEMPLICE E DOPPIO - PROTEZIONE CIRCOLARE

SIMPLE WALL AND DOUBLE WALL POLYOLEFYNE (TPO) ROOF VENT - PROTECTION COLLAR
AIREADOR DE POLIOLEFINA (TPO) SIMPLE Y DOBLE - PROTECCIÓN CIRCULAR

Realizzati in Poliolefine universale di colore bianco, sono creati per garantire la massima compatibilità con qualsiasi membrana in Poliolefine. Disponibili in due modelli, il tipo "semplice", che si usa solo in presenza di membrana impermeabile, il tipo "doppio" che si usa nel caso venga applicato un pannello isolante. Raccomandiamo l'utilizzo dell'apposita protezione circolare.

Manufactured of universal Polyolefine white, they are made to guarantee a perfect compatibility to any sort of TPO waterproofing membrane. It is available in the following models: the simple wall version used in case of a simple waterproofing membrane and the double wall version used in the presence of insulating boards. For a further protection, a specific collar is also provided.

Realizadas con Poliolefina universal de color blanco, se han creado para garantizar la máxima compatibilidad con cualquier membrana de poliolefina. Disponibles en dos modelos: el tipo "simple", que se usa cuando solo hay una membrana impermeable, y el tipo "doble", que se usa cuando se aplica un panel aislante. Se aconseja emplear la protección circular.

ESALATORE SEMPLICE H 225mm SIMPLE ROOF VENT H 225mm SIMPLE AIREADOR H 225mm

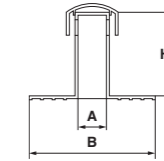

Codice Code Codigo HIFAX	Codice Code Codigo ADFLEX*	Tipo Type Tipo	Ø esterno Ø external Ø externo	A	B	H	H1		
D401325075	D401225075	Semplice Simple wall Simple	75	72	300	225	-	25	225

* Prodotto ADFLEX a richiesta ADFLEX type on request Producto ADFLEX bajo pedido



ESALATORE DOPPIO H 225mm DOUBLE ROOF VENT H 225mm DOBLE AIREADOR H 225mm

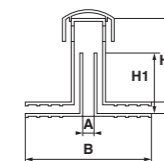

Codice Code Codigo HIFAX	Codice Code Codigo ADFLEX*	Tipo Type Tipo	Ø esterno Ø external Ø externo	A	B	H	H1		
D410325075	D410225075	Doppio Double wall Doble wall	75	60	300	225	190	25	225



PROTEZIONE CIRCOLARE PROTECTION COLLAR PROTECCIÓN CIRCULAR

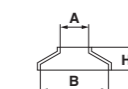

Codice Code Codigo HIFAX	Codice Code Codigo ADFLEX*	Tipo Type Tipo	Ø esterno Ø external Ø externo	A	B	H	H1		
D150000000	D150000000	Protezione circolare Protection collar Protección collar	-	75	180	60	-	25	1750



TPO

TPO

SSS

PAG. LISTINO
PAGE LIST
PÁG. LIST. 23

RACCORDO PER TUBI IN TPO RACCORDO CONICO IN TPO

TPO BASE FITTING FOR PIPES - TPO CONICAL BASE FITTING FOR PIPES ESPIGÓN PARA TUBOS DE TPO - ESPIGÓN CÓNICO DE TPO

I raccordi vengono applicati nei casi in cui fuoriescano dei tubi di sfogo dal solaio di copertura. L'applicazione è molto semplice, basta tagliare in corrispondenza della sezione richiesta, inserirlo all'esterno del tubo e sigillare mediante fascetta metallica stringitubo.

Base fittings are available to solve the problem of ventilation pipes coming out from the roofing floor. The application is very simple. The base fittings shall be cut according to the pipe diameter required and then slipped on to the pipe. A metal ring to squeeze the rubber connection around the pipe will finish the operation.

Los espigones se aplican cuando sobresalen tubos de desahogo a través de la cubierta. La aplicación es muy fácil: solo hay que cortar el espigón en correspondencia de la sección deseada, introducirlo en el exterior del tubo y sellarlo mediante una abrazadera metálica.

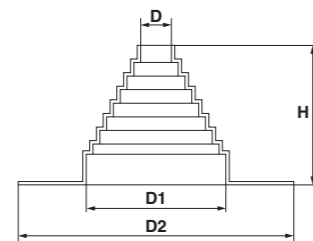

Codice Code Codigo HIFAX	Codice Code Codigo ADFLEX*	D	D1	D2	H		
F002003010	F002003000	40	175	395	190	12	360

* Prodotto ADFLEX a richiesta
ADFLEX type on request
Producto ADFLEX bajo pedido

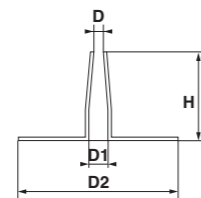

Codice Code Codigo HIFAX	Codice Code Codigo ADFLEX*	D	D1	D2	H		
F013003002	F013003000	15	30	210	120	50	2100

* Prodotto ADFLEX a richiesta
ADFLEX type on request
Producto ADFLEX bajo pedido



TPO

TPO

SSS

PAG. LISTINO
PAGE LIST
PÁG. LIST. 23

PROFILI PERIMETRALI PER MEMBRANE IN TPO

PERIMETRAL PROFILES FOR TPO MEMBRANES PERFILES PERIMÉTRICOS PARA MEMBRANAS DE TPO

I profili perimetrali sono compatibili con qualsiasi membrana impermeabile in Poliolefine (TPO). Sono realizzati in lamiera zincata accoppiata ad un membrana TPO.

This kind of profile is perfectly compatible to any kind of TPO waterproofing membrane. It is manufactured with galvanized-plate combined to a TPO sheet.

Los perfiles perimétricos son compatibles con cualquier membrana impermeable de TPO. Se realizan con chapa cincada combinada con TPO.



Profilo a parete
sviluppo 70 mm - lunghezza 2 mt
Perimetral wall profile
height 70 mm - length 2 mt
Perfil de pared
desarrollo mm 70 - longitud m 2



Piattina di fissaggio
sviluppo 50 mm - lunghezza 2 mt
Fixing flat element
height 50 mm - length 2 mt
Pletina de fijación
desarrollo mm 50 - longitud m 2

Codice Code Codigo	Tipo Type Tipo		
F041107002	70 mm	2	-
F040105002	50 mm	2	-



TPO

TPO

SSS

PAG. LISTINO
PAGE LIST
PÁG. LIST. 24



VUOI MAGGIORI
INFORMAZIONI?

NEED MORE
INFORMATIONS?

¿QUIERES MÁS
INFORMACIÓN?



> POSA IN OPERA
ACCESSORI PER MANTI SINTETICI PVC -TPO

> ACCESSORIES FOR PVC - TPO
LAYERS INSTALLATION

> PUESTA EN OBRA
ACCESORIOS PARA MEMBRANAS
IMPERMEABLES DE PVC - TPO

ANGOLI INTERNI ED ESTERNI IN TPO

TPO

TPO

SSS

TPO INTERNAL AND EXTERNAL CORNER ÁNGULOS INTERNOS Y EXTERNOS DE TPO

Gli angoli interni ed esterni in TPO sono elementi molto importanti ed indispensabili al completamento di una impermeabilizzazione con membrane poliolefiniche. Servono infatti a proteggere e rinforzare gli spigoli e gli angoli presenti nella copertura da impermeabilizzare per esempio in presenza di muri e lucernari. Sono disponibili nei modelli MINI, MEDIO e l'esclusiva versione MAXI con un'altezza di ben 150mm per offrire una superficie impermeabilizzante davvero fuori standard.

TPO internal and external corners are element of a high importance and needed to finish a waterproofing with single-ply TPO membranes. The main purpose of these items is to protect and reinforce the waterproofing sheet on corners and edges in presence of walls and skylights. They are available in different types: the brand new MINI type, MEDIUM and the exclusive MAXI type that thanks to its large surface (150mm high) is a unique version that offers a very wide waterproofing area.

Los ángulos internos y externos de TPO son unos elementos muy importantes e indispensables para completar las impermeabilizaciones con membranas de poliolefina. En efecto, sirven para proteger y reforzar las esquinas y los ángulos presentes en el techo que se debe impermeabilizar, por ejemplo, cuando hay paredes y claraboyas. Se encuentran disponibles en los nuevos modelos MINI, MEDIO y la exclusiva versión MAXI con una altura de 150 mm para ofrecer una superficie impermeabilizante verdaderamente fuera de lo estándar.

PAG. LISTINO
PAGE LIST
PÁG. LIST. 24

ANGOLO INTERNO MINI INTERNAL CORNER MINI ÁNGULO INTERNO MINI

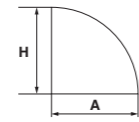

Codice Code Codigo HIFAX	Codice Code Codigo ADFLEX*	A	B	H	Pz	Pz
F011004200	F011004210	70	-	70	350	-



ANGOLO ESTERNO MINI EXTERNAL CORNER MINI ÁNGULO ESTERNO MINI

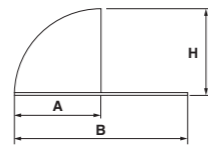

Codice Code Codigo HIFAX	Codice Code Codigo ADFLEX*	A	B	H	Pz	Pz
F010004200	F010004210	67	128	70	200	-



* Prodotto ADFLEX a richiesta
ADFLEX type on request
Producto ADFLEX bajo pedido

ANGOLO INTERNO MEDIO INTERNAL CORNER MEDIUM ÁNGULO INTERNO MEDIO

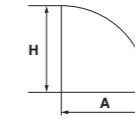

Codice Code Codigo HIFAX	Codice Code Codigo ADFLEX*	A	B	H	Pz	Pz
F011004020	F011004000	95	-	95	200	6000**



ANGOLO ESTERNO MEDIO EXTERNAL CORNER MEDIUM ÁNGULO ESTERNO MEDIO

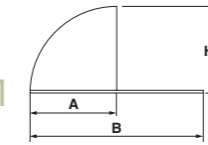

Codice Code Codigo HIFAX	Codice Code Codigo ADFLEX*	A	B	H	Pz	Pz
F010004020	F010004000	93	173	100	100	3000**



ANGOLO INTERNO MAXI INTERNAL CORNER MAXI ÁNGULO INTERNO MAXI

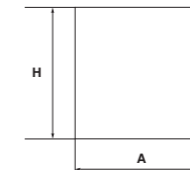

Codice Code Codigo HIFAX	Codice Code Codigo ADFLEX*	A	B	H	Pz	Pz
F011004030	F011004040	150	-	150	80	1600**



ANGOLO ESTERNO MAXI EXTERNAL CORNER MAXI ÁNGULO ESTERNO MAXI

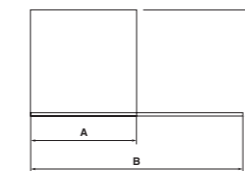

Codice Code Codigo HIFAX	Codice Code Codigo ADFLEX*	A	B	H	Pz	Pz
F010004030	F010004040	150	400	150	40	800**



** Dimensioni pallet Pallet size Dimensiones paleta: mm 1200 x 800 x h 1100

TPO

TPO

SSS

PAG. LISTINO
PAGE LIST
PÁG. LIST. 24



BOCCHETTONI "EURO" IN TPE FLAT CON FLANGIA LISCIA E CODOLO H 400 mm

TPE FLAT "EURO" ROOF OUTLET WITH SMOOTH FLANGE AND 400 mm SPIGOT
CAZOLETAS "EURO" DE TPE FLAT CON REBORDE LISO Y MANGUETÓN H 400 mm

I nuovi bocchettoni in TPE con flangia liscia sono stati appositamente creati per l'applicazione di membrane in EPDM, gomma butilica e similari. Non potendoci essere compatibilità chimica, la flangia liscia funge infatti da supporto ottimale per la stesura di collanti o bande biadesive appositamente sviluppate per l'incollaggio di tali membrane. Il codolo è fornito di una serie di alette antirigurgito che prevengono infiltrazioni in caso di riflusso d'acqua.

The new TPE roof outlets with smooth flange have been properly developed as the ideal solution for the adhesion of synthetic EPDM, butyl rubber and similar waterproofing membranes. Since no chemical welding is possible, the smooth flange offers an ideal laying support for glues or self adhesive bands. The spigot is provided with anti-infiltration tongues to prevent infiltration in case of water back-up.

Las nuevas cazoletas de TPE con reborde liso se han creado especialmente para la aplicación de membranas de EPDM, goma butilica y otros materiales similares. Al no haber compatibilidad química, el reborde liso es un óptimo soporte para aplicar los adhesivos o las cintas biadhesivas especialmente desarrolladas para pegar dichas membranas. El manguetón se suministra de serie con aletas antirretorno que evitan las filtraciones en caso de refluo del agua.

TPE
FLAT

EPDM



24 PAG. LISTINO
PAGE LIST
PÁG. LIST.

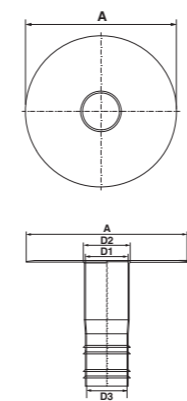

Codice Code Codigo	Per tubi For pipes Para tubos	A	D1	D2	D3	H		
A013041063	Ø 63	320	51	60	49	400	15	240
A013041075	Ø 75	320	63	70	62	400	15	240
A013041082	Ø 82	320	69	75	68	400	15	240
A013041090	Ø 90	320	80	84	79	400	15	240
A013041100	Ø 100	320	86	90	85	400	15	240
A013041110	Ø 110	380	95	101	94	400	12	192
A013041125	Ø 125	380	109	115	108	400	12	96
A013041140	Ø 140	380	128	134	127	400	10	80
A013041150	Ø 150	380	134	140	132	400	10	80
A013041160	Ø 160	380	140	146	139	400	10	80

BOCCHETTONI ANGOLARI IN TPE FLAT CON FLANGIA LISCIA



PAG. LISTINO
PAGE LIST
PÁG. LIST. 25

TPE FLAT ANGULAR DRAIN OUTLET WITH SMOOTH FLANGE CAZOLETAS ANGULARES DE TPE FLAT CON REBORDE LISO

Come per la versione verticale, anche la nuova gamma di bocchettoni a scarico laterale in TPE con flangia liscia sono stati creati per l'applicazione di membrane sintetiche in EPDM, gomma butilica e similari. Il codolo orizzontale è disponibile in diverse misure con sezione quadrata, rettangolare o tonda.

As for the vertical version, the new range of TPE angular outlets with smooth flange has been created as ideal solution for a perfect adhesion of synthetic EPDM, butyl rubber and similar waterproofing membranes. The exit spigot is available in different sizes and squared, rectangular or round sections.

Como para la versión vertical, también la nueva gama de cazoletas con desagüe lateral de TPE y reborde liso se han creado para la aplicación de membranas sintéticas de EPDM, goma butilica y otros materiales similares. El manguetón horizontal se encuentra disponible en diferentes medidas con sección cuadrada, rectangular o redonda.

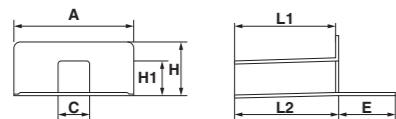

SEZIONE mm 100 X 100 100 X 100 mm SECTION SECCIÓN mm 100 X 100

Codice Code Código	Tipo Type Tipo	A	C	E	H	H1	L1	L2	Pz	Pz
A041375012	90°	340	92	145	168	92	375	375	5	80

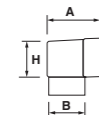

RACCORDO SEZIONE mm 100 X 100 PIPE ADAPTOR 100 X 100 mm SECTION CONECTOR SECCIÓN mm 100 X 100

Codice Code Código	Misura Size Medida	A	B	H	D	H	Pz	Pz
F071080010	∅ 80	148	78	95	-	-	10	700
F071100010	∅ 100	148	96	96	-	-	10	700

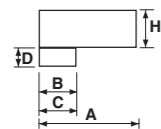

RACCORDO SEZIONE mm 100 X 65 PIPE ADAPTOR 100 X 65 mm SECTION CONECTOR SECCIÓN mm 100 X 65

Codice Code Código	Misura Size Medida	A	B	H	D	H	Pz	Pz
F072063080	∅ 63 - 80	218	63	80	45	65	10	360
F072080100	∅ 80 - 100	218	80	100	62	65	10	360

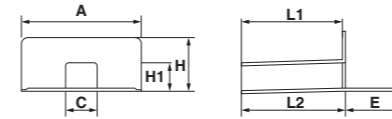

SEZIONE mm 100 X 65 100 X 65 mm SECTION SECCIÓN mm 100 X 65

Codice Code Código	Tipo Type Tipo	A	C	E	H	H1	L1	L2	Pz	Pz
A042425066	90°	340	92	145	168	62	425	425	10	140

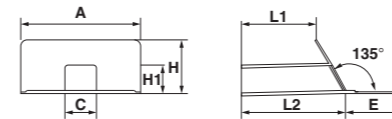

SEZIONE mm 100 X 65 100 X 65 mm SECTION SECCIÓN mm 100 X 65

Codice Code Código	Tipo Type Tipo	A	C	E	H	H1	L1	L2	Pz	Pz
A040425066	45°	340	95	145	115	62	340	425	10	140

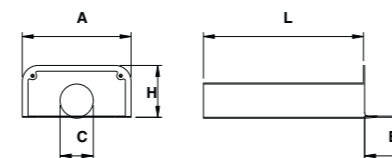

BOCCHETTONE ANGOLARE USCITA TONDA FLANGIA LISCIA ANGULAR DRAIN WITH ROUND SPIGOT SMOOTH FLANGE CAZOLETA ANGULAR CON SALIDA REDONDA Y REBORDE LISO

Codice Code Código	Per tubi For Pipes Para tubos	A	C	E	H	L	Pz	Pz
A045501063	∅ 63	340	63	150	133	500	8	80
A045501075	∅ 75	340	75	150	133	500	8	80
A045501080	∅ 80	340	80	150	165	500	8	80
A045501090	∅ 90	340	90	150	165	500	8	80
A045501100	∅ 100	340	100	150	165	500	8	80
A045501110	∅ 110	340	110	150	165	500	8	80
A045501125	∅ 125	340	125	150	165	500	7	70



PAG. LISTINO
PAGE LIST
PÁG. LIST. 25

ESALATORE IN TPE FLAT CON FLANGIA LISCIA PROTEZIONE CIRCOLARE

TPE FLAT ROOF VENT PIPES WITH SMOOTH FLANGE - PROTECTION COLLAR AIREADORES DE TPE FLAT CON REBORDE LISO - PROTECCIÓN CIRCULAR

La nuova gamma di esalatori in TPE con flangia liscia è stata anch'essa creata per l'applicazione di membrane sintetiche in EPDM, gomma butilica e similare. Sono disponibili nei modelli tipo "semplice", che si usa in presenza della sola membrana impermeabile ed il tipo "doppio" che si usa in presenza di un pannello isolante. Raccomandiamo l'uso dell'apposita protezione circolare.

The new range of TPE roof air vents with smooth flange has been also created as ideal solution for a perfect adhesion of synthetic EPDM, butyl rubber and similar waterproofing membranes. As usually they are available in the following models: the simple wall version used in case of a simple waterproofing membrane and the double wall version used in the presence of any insulation. For a further protection, a specific collar is also provided.

La nueva gama de aireadores de TPE con reborde liso también se ha creado para la aplicación de membranas de EPDM, goma butilica y otros materiales similares. Se encuentran disponibles en los modelos de tipo "simple", que se usa cuando solo hay una membrana impermeable, y de tipo "doble", que se usa cuando hay un panel aislante. Se aconseja emplear siempre la correspondiente protección circular.



PAG. LISTINO
PAGE LIST
PÁG. LIST.

26

ESALATORE SEMPLICE H 225 mm SIMPLE ROOF VENT H 225 mm SIMPLE AIREADOR H 225 mm

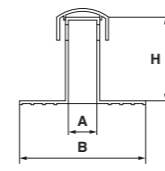

Codice Code Codigo HIFAX	Tipo Type Tipo	Ø esterno Ø external Ø externo	A	B	H	H1		
D020225075	Semplice Simple wall Simple	75	72	300	225	-		

ESALATORE DOPPIO H 225 mm DOUBLE ROOF VENT H 225 mm DOBLE AIREADOR H 225 mm

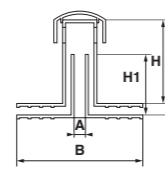

Codice Code Codigo HIFAX	Tipo Type Tipo	Ø esterno Ø external Ø externo	A	B	H	H1		
D036225075	Doppio Double wall Doble	75	60	300	225	190		

PROTEZIONE CIRCOLARE PROTECTION COLLAR PROTECCIÓN CIRCULAR

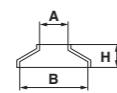

Codice Code Codigo HIFAX	Tipo Type Tipo	Ø esterno Ø external Ø externo	A	B	H	H1		
D150000000	Protezione circolare Protection collar Protección circular	-	75	180	60	-		

RACCORDO PER TUBI IN TPE FLAT RACCORDO CONICO IN TPE FLAT

TPE FLAT PIPES PROTECTION BASE FITTING WITH SMOOTH FLANGE ESPIGÓN PARA TUBOS Y ESPIGÓN CÓNICO DE TPE FLAT

I raccordi vengono applicati nei casi in cui fuoriescano dei tubi di sfogo dal solaio di copertura. L'applicazione è molto semplice, basta tagliare in corrispondenza della sezione richiesta, inserirlo all'esterno del tubo e sigillare mediante fascetta metallica stringitubo.

Base fittings are available to solve the problem of ventilation pipes coming out through the roofing floor. The application is very simple. The base fittings shall be cut according to the pipe diameter required and then slipped on to the pipe. A metal ring to squeeze the rubber connection around the pipe will finish the operation.

Los espigones se aplican cuando sobresalen tubos de desahogo a través de la cubierta. La aplicación es muy fácil: solo hay que cortar el espigón en correspondencia de la sección deseada, introducirlo en el exterior del tubo y sellarlo mediante una abrazadera metálica.

Codice Code Codigo	Tipo Type Tipo	D	D1	D2	H		
F001000100	TPE	40	175	395	190		

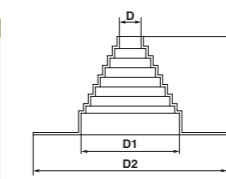

Codice Code Codigo	Tipo Type Tipo	D	D1	D2	H		
F013000000	TPE	15	30	210	120		

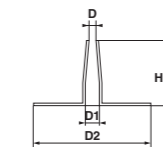

PAG. LISTINO
PAGE LIST
PÁG. LIST.

26

ANGOLI IN TPE FLAT

TPE FLAT CORNERS ÁNGULOS DE TPE FLAT

Servono per rinforzare gli spigoli e gli angoli delle coperture impermeabilizzate.

The main purpose of these items is to reinforce the waterproofing sheet on corners and edges.

Sirven para reforzar las aristas y los ángulos de las cubiertas impermeabilizadas.

Codice Code Codigo	Tipo Type Tipo	A	B	H		
F011001100	Angolo interno medio Internal corner medium Ángulo interno medio	95	-	95	200	6000*

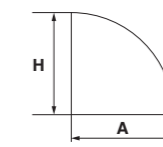

Codice Code Codigo	Tipo Type Tipo	A	B	H		
F010001100	Angolo esterno medio External corner medium Ángulo externo medio	95	175	100	100	3000*

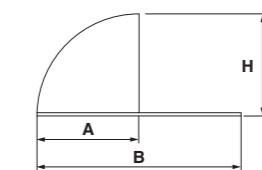

* Dimensioni pallet: Pallet size: Dimensiones paleta: mm 1200 x 800 x h 1100



PAG. LISTINO
PAGE LIST
PÁG. LIST.

26

BOCCHETTONI "EURO" IN ECB CON CODOLO H 250 mm

ROOF DRAIN "EURO" MADE OF ECB WITH A 250 mm H SPIGOT
CAZOLETA "EURO" DE ECB CON MANGUETÓN H 250 mm

Realizzati in ECB per garantire la compatibilità con qualsiasi tipo di membrana impermeabile in ECB e bituminoso in SBS. La flangia è liscia, in modo da consentire una perfetta fusione con la membrana impermeabile. Il codolo è dotato di due coppie di alette antiriflusso.

Manufactured in ECB to guarantee a perfect compatibility to any sort of ECB waterproofing single-ply and SBS bituminous membrane. The flange is totally smooth for a perfect bonding to the waterproofing membrane. The spigot is provided with two couples of anti-infiltration tongues.

Realizadas con ECB para garantizar la compatibilidad con cualquier membrana impermeable de ECB y bituminosa de SBS. El reborde es liso para permitir una perfecta fusión con la membrana impermeable.

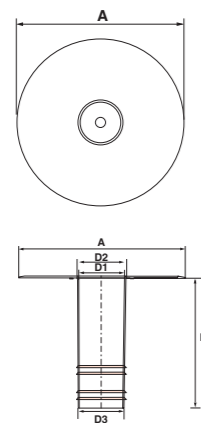

Codice Code Codigo	Per tubi For pipes Para tubos	A	D1	D2	D3	H	Pz	Pz
A013325075	Ø 75	320	63	70	62	250	15	240
A013325082	Ø 82	320	69	75	68	250	15	240
A013325100	Ø 100	320	86	90	85	250	15	240
A013325110	Ø 110	380	95	101	94	250	15	240
A013325125	Ø 125	380	109	115	108	250	15	240

NB: Su richiesta, qualsiasi articolo in PVC può essere fornito anche in ECB. Quantità minime da rispettare
NB: On request, any PVC item can be manufactured in ECB too. Minimum quantities to be matched.
N.B.: Bajo pedido, cualquier artículo de PVC se puede suministrar también de ECB. Cantidades mínimas por respetar.

ECB

ECB
SBS



PAG. LISTINO
PAGE LIST
PÁG. LIST.
26

BOCCHETTONE ANGOLARE L 425 mm SEZIONE 100 X 65 mm IN ECB

ANGULAR DRAIN - L 425 mm SECTION 100 X 65 mm MADE OF ECB
CAZOLETA ANGULAR - L 425 mm SECCIÓN 100 X 65 mm DE ECB

Realizzati in ECB per garantire la compatibilità con qualsiasi membrana impermeabile in ECB e bituminosa in SBS. La flangia è liscia, in modo da consentire una perfetta fusione con la membrana impermeabile. La versione 100x65 mm è dotata di raccordi per i tubi di scarico, vedi a pag. 72.

Manufactured in ECB to guarantee a perfect compatibility to any sort of ECB waterproofing single-ply and SBS bituminous membrane. The flange is totally smooth for a perfect bonding between the roof drain and the waterproofing membrane. See on page 72 for pipe adaptors for 100 x 65 mm version.

Realizadas con ECB para garantizar la compatibilidad con cualquier membrana impermeable de ECB y bituminosa de SBS. El reborde es liso para permitir una perfecta fusión con la membrana impermeable. La versión 100x65 mm posee conectores para los tubos de desagüe (véase pág. 72).

SEZIONE mm 100 X 65
100 X 65 mm SECTION
SECCIÓN mm 100 X 65

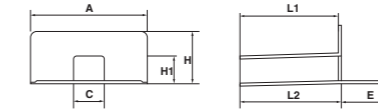

Codice Code Codigo	Tipo Type Tipo	A	C	E	H	H1	L1	L2	Pz	Pz
A042425365	90°	340	92	145	168	62	425	425	8	112

SEZIONE mm 100 X 65
100 X 65 mm SECTION
SECCIÓN mm 100 X 65

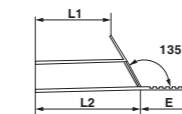

Codice Code Codigo	Tipo Type Tipo	A	C	E	H	H1	L1	L2	Pz	Pz
A040425365	45°	340	95	145	115	62	340	425	8	112



ECB

ECB
SBS



PAG. LISTINO
PAGE LIST
PÁG. LIST.
27

BOCCHETTONE ANGOLARE IN ECB CON CODOLO TONDO

ANGULAR DRAIN MADE OF ECB WITH ROUND SPIGOT
CAZOLETA ANGULAR DE ECB CON MANGUETÓN REDONDO

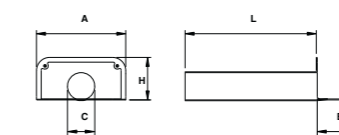

Codice Code Codigo	Per tubi For pipes Para tubos	A	C	E	H	L	Pz	Pz
A049500063	Ø 63	340	63	150	133	500	8	80
A049500075	Ø 75	340	75	150	133	500	8	80
A049500090	Ø 90	340	90	150	165	500	8	80
A049500110	Ø 110	340	110	150	165	500	8	80
A049500125	Ø 125	340	125	150	185	500	7	70



ECB

ECB
SBS



PAG. LISTINO
PAGE LIST
PÁG. LIST.
27

ESALATORE IN ECB - PROTEZIONE CIRCOLARE

RACCORDO PER TUBI IN ECB RACCORDO CONICO IN ECB

ECB

ECB
SBS



PAG. LISTINO
PAGE LIST
PÁG. LIST.

27

WALL ECB ROOF VENT PIPE - PROTECTION COLLAR AIREADOR DE ECB - PROTECCIÓN CIRCULAR

Realizzati in ECB per garantire la compatibilità con qualsiasi tipo di membrana in ECB e bituminoso in SBS. È realizzato in due modelli: il tipo "semplice", che si usa in presenza della sola membrana impermeabile ed il tipo "doppio" che si usa in presenza di un pannello isolante. Raccogliamo l'utilizzo dell'apposita protezione circolare.

Manufactured in ECB to guarantee a perfect compatibility to any sort of ECB waterproofing single-ply and SBS bituminous membrane, it is available in the following models: the simple wall version used in case of a simple waterproofing membrane and the double wall version used in the presence of insulating boards. For a further protection, a proper collar is provided and recommended.

Realizadas con ECB para garantizar la compatibilidad con cualquier tipo de membrana de ECB y bituminosa de SBS. Se realiza en dos modelos: el tipo "simple", que se usa cuando solo hay una membrana impermeable, y el tipo "doble", que se usa cuando hay un panel aislante. Se aconseja emplear la protección circular.

SEMPLICE H 225 - Ø 75 mm SIMPLE H 225 - Ø 75 mm SIMPLE H 225 - Ø 75 mm

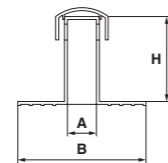

Codice Code Codigo	Ø esterno Ø external Ø externo	A	B	H	H1	Pz	Pz
D018225075	75	72	300	225	-	25	225

DOPPIO H 225 - Ø 75 mm DOUBLE H 225 - Ø 75 mm DOBLE H 225 - Ø 75 mm

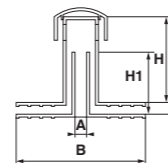

Codice Code Codigo	Ø esterno Ø external Ø externo	A	B	H	H1	Pz	Pz
D034225075	75	60	300	225	190	25	225

PROTEZIONE CIRCOLARE PROTECTION COLLAR PROTECCIÓN CIRCULAR

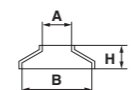

Codice Code Codigo	Ø esterno Ø external Ø externo	A	B	H	H1	Pz	Pz
D150000000	-	75	180	60	-	25	1750

* Dimensioni pallet: Pallet size: Dimensiones paleta: mm 1200 x 800 x h 1100

ECB

ECB
SBS



27

PAG. LISTINO
PAGE LIST
PÁG. LIST.

ECB CONICAL BASE FITTING FOR PIPES ESPIGÓN PARA TUBOS DE ECB - ESPIGÓN CÓNICO DE ECB

I raccordi per tubi sono elementi molto utili per impermeabilizzare qualsiasi tipologia di tubo che fuoriesca attraverso il solaio di copertura.

Base fittings are useful elements to waterproof different sorts of pipes coming out through the roofing floor

Los espigones para tubos son elementos muy útiles para impermeabilizar cualquier tipo de tubo que salga por la cubierta.

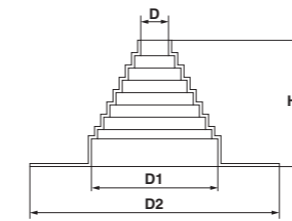

Codice Code Codigo	Tipo Type Tipo	D	D1	D2	H	Pz	Pz
F002002000	Raccordo per tubi Base fittings for pipes Espigón para tubos	40	175	395	190	12	360

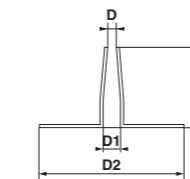

Codice Code Codigo	Tipo Type Tipo	D	D1	D2	H	Pz	Pz
F013002000	Raccordo conico Conical base fitting Espigón cónico	15	30	210	120	50	2100

ANGOLI "MEDI" E "MAXI" IN ECB

ECB "MEDIUM" AND "MAXI" CORNERS ÁNGULOS "MEDIOS" Y "MAXI" DE ECB

Gli angoli Medi e gli angoli Maxi si differenziano tra loro solo per le dimensioni. Sono entrambi disponibili nei modelli "Interno" ed "Esterno" e sono molto utili per rinforzare gli angoli e gli spigoli nelle coperture impermeabilizzate.

Medium and Maxi corners are simply different each other in sizes, offering a different covering surface. Both are available in the "Internal" and "External" versions and are very useful to reinforce the waterproofing sheet on corners and edges.

Los ángulos Medi y Maxi se diferencian entre sí solo por las dimensiones. Ambos están disponibles en los modelos "Interno" y "Eterno" y son muy útiles para reforzar los ángulos y las aristas de las cubiertas impermeabilizadas.

ECB

ECB
SBS



PAG. LISTINO
PAGE LIST
PÁG. LIST.
28

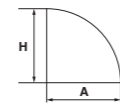

Codice Code Codigo	Tipo Type Tipo	A	B	H		
F011002101	Angolo interno medio Internal corner medium Ángulo interno medio	95	-	95	200	6000*

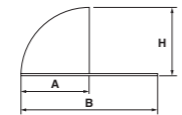

Codice Code Codigo	Tipo Type Tipo	A	B	H		
F010002101	Angolo esterno medio External corner medium Ángulo externo medio	93	173	100	100	3000*

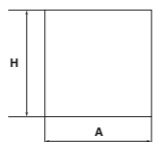

Codice Code Codigo	Tipo Type Tipo	A	B	H		
F011002010	Angolo interno maxi Internal corner maxi Ángulo interno maxi	150	-	150	80	1280*

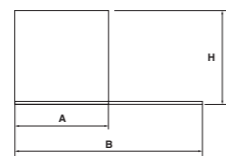

Codice Code Codigo	Tipo Type Tipo	A	B	H		
F010002010	Angolo esterno maxi External corner maxi Ángulo externo Maxi	150	400	150	40	640*

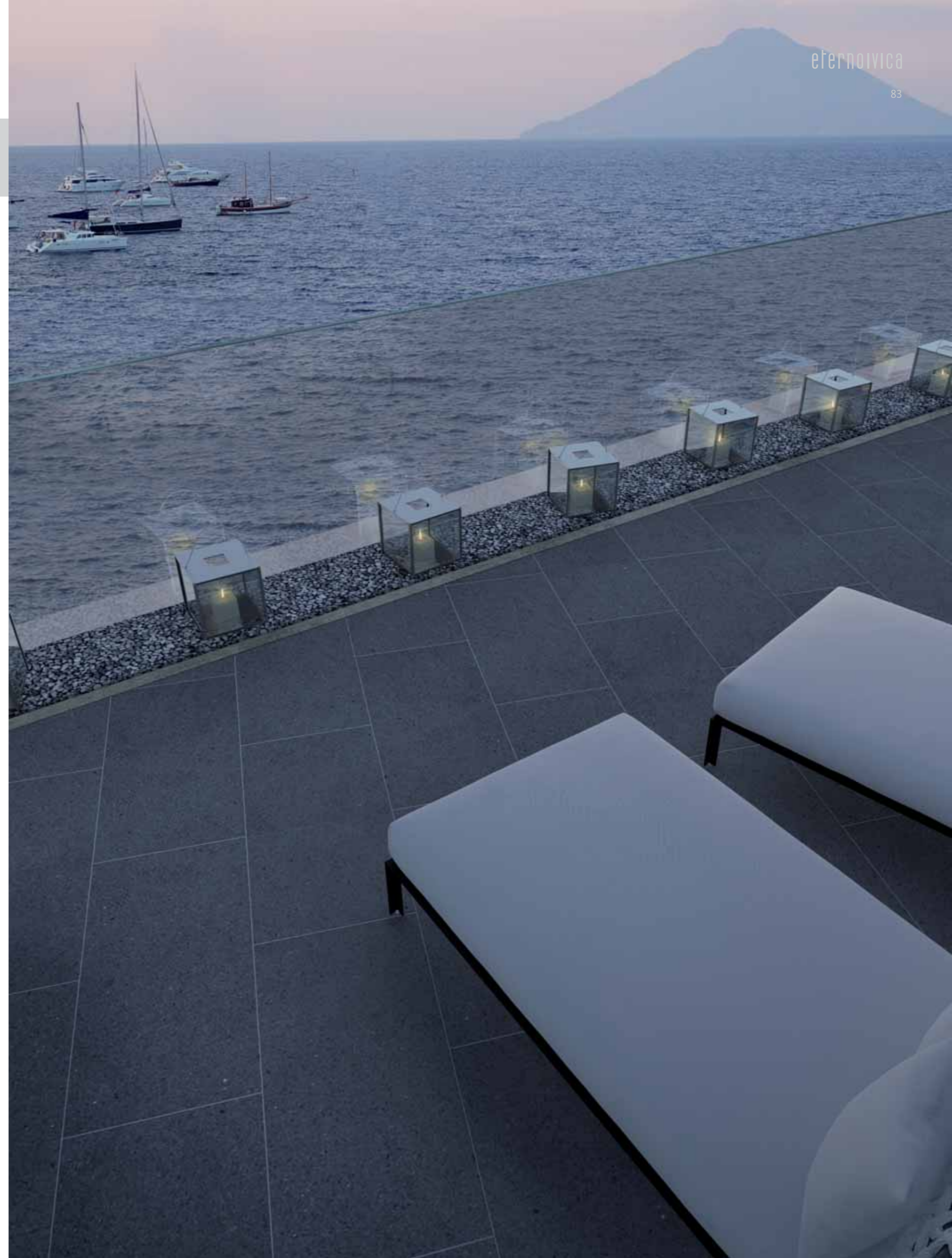

PARAFOGLIE

LEAF-GUARDS PARAHOJAS

■ Per bocchettoni di scarico Ø da 60 a 120 mm
For Ø 60 mm to Ø 120 mm drain outlets
Para cazoletas de desagüe con Ø de 60 a 120 mm



Borchia stringifilo senza saldature
Weldless wire escutcheon
Aprietahilos sin soldaduras

Unico filo di zinco (Ø 2,7 mm) senza saldature
Single weldless zinc wire (Ø 2.7 mm)
Único hilo de cinc (Ø 2,7 mm) sin soldaduras

■ Per bocchettoni di scarico Ø da 60 a 140 mm
For Ø 60 mm to Ø 140 mm drain outlets
Para cazoletas de desagüe con Ø de 60 a 140 mm



Anello di rinforzo
Reinforcement ring
Anillo de refuerzo

Unico elemento in PP
Single element in PP
Único elemento de PP

Speciale grip per inserimento nei bocchettoni di scarico
Special grip for insertion into the drain outlets
Grip especial para el montaje en cazoletas de desagüe

VERSIONI VERSIONS VERSIONES

PRODOTTO IN PP
Ø DA 60 mm
A 200 mm
MADE OF PP
Ø FROM 60 mm
to 200 mm
*FABRICADO EN PP
Ø DA 60 mm A 200 mm*

PRODOTTO
IN RAME
E ACCIAIO INOX
MADE OF COPPER AND
STAINLESS STEEL
*FABRICADO EN COBRE
Y ACERO
INOXIDABLE*

PRODOTTO
IN PP UNIVERSALE
Ø DA 60 mm
A 140 mm
MADE OF UNIVERSAL PP
Ø FROM 60 mm
to 140 mm
*FABRICADO EN PP
UNIVERSAL
Ø DA 60 mm A 140 mm*

VERSIONI VERSIONS VERSIONES

PARAGHIAIA
IN PP
GRAVEL-GUARD
MADE OF PP
*PARAGRAVAS
FABRICADO EN PP*

RETE
PROTEGGI-GRONDE
EAVES
GUTTER-GUARD
*RED DE PROTECCIÓN
DE CANALONES*

PRODOTTO
IN PP PER
BOCCHETTONI
ANGOLARI
MADE OF PP
FOR ANGULAR ROOF
DRAIN
*FABRICADO EN PP
PARA CAZOLETAS
ANGULARES*

PARAFOGLIE UNIVERSALI IN PP, ZINCO, RAME, ACCIAIO INOX E PER BOCCHETTONE ANGOLARE 45°



PP, ZINC, COPPER AND STAINLESS STEEL LEAF-GUARDS AND PP LEAF-GUARD FOR 45° ANGULAR DRAIN
 PARAHOJAS UNIVERSALES DE PP, CINC, COBRE, ACERO INOXIDABLE Y PARA CAZOLETA ANGULAR 45°

Per proteggere le condotte di scarico da foglie e sporcizia in genere, c'è la possibilità di applicare la parafoglia al bocchettone. La gamma ETERNO offre più di una possibilità: una parafoglia in PP a misura fissa, da Ø 60 a 200 mm, una parafoglia in PP a misura variabile da Ø 60 a 140 mm, una parafoglia metallica in zinco, rame o acciaio inox a misura variabile da Ø 60 a 120 mm, una parafoglia specifica per bocchettone angolari a 45°.

To protect the drain-pipe from leaves and dirt, we always recommend to install a leaf-guard on the roof drain. The ETERNO range offers leaf-guards made of PP with fixed size from 60 to 200 mm diameter, a PP leafguard with variable size from 60 to 140 mm diameter, metallic leafguards made of zinc, copper and stainless steel with variable size from Ø 60 to Ø 120 mm, and a specific PP leaf-guard for angular drains with a 45° corner.

Para proteger los conductos de desagüe de las hojas y, en general, de la suciedad, es posible aplicar parahojas a la cazoleta. La gama ETERNO ofrece más de una posibilidad: un parahojas de PP de medida fija, de Ø 60 a 200 mm, un parahojas de PP de medida variable de Ø 60 a 140 mm, un parahojas metálico de cinc, cobre o acero inoxidable de medida variable de Ø 60 a 120 mm, un parahojas específico para cazoletas angulares de 45°.

PAG. LISTINO
 PAGE LIST
 PÁG. LIST.
 28

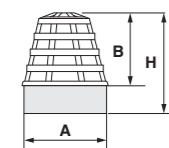

PARAFOGLIA PP A MISURA FISSA FIXED SIZE PP LEAF-GUARD PARAHOJAS DE PP DE MEDIDA ÚNICA

Codice Code Codigo	Ø	A	B	H	Pz	Eterno h 200 Ø	Eterno h500 Ø	Mondial Ø	Euro/Genius Ø
C001000060	60	47	54	84	25	50 - 60		60	
C001000075	75	62	75	105	25	75			
C001000080	80	68	70	100	25	80		80	90
C001001080	80L	68	70	100	25				82
C001000090	90	78	70	100	25	90	80		100
C001000100	100	88	70	100	25	100		100	
C001000110	110	92	70	100	25	110			110
C001000120	120	100	70	100	25	120		120	125
C001001120	120L	100	70	100	25		100		
C001000125	125	109	70	100	20	125			
C001000140	140	125	70	100	20	140	120		140
C001000150	150	130	70	100	15	150		150	150
C001000160	160	143	75	105	15	160	150		
C001000200	200	177	75	105	10	200			

Individua il diametro del tuo bocchettone e scegli il parafoglia corrispondente
 Match the diameter of your drain and choose the right leaf guard
 Determina el diámetro de la cazoleta y elije el parahojas que le corresponde

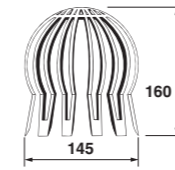

PARAFOGLIA UNIVERSALE IN PP FLEXIBLE PP LEAF-GUARD PARAHOJAS UNIVERSAL DE PP

Codice Code Codigo	Misura Size Medida	Tipo Type Tipo	Pz	Pz
C005000000	60±140	Special PP Especial PP	100	2000
C005000001	60±140	Standard PP Estándar PP	100	2000

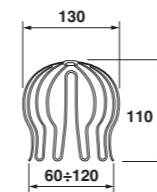

PARAFOGLIA UNIVERSALE IN ZINCO, RAME, ACCIAIO FLEXIBLE ZINC, COPPER, STAINLESS STEEL LEAF-GUARD PARAHOJAS UNIVERSAL DE CINC, COBRE Y ACERO

Codice Code Codigo	Misura Size Medida	Tipo Type Tipo	Pz	Pz
C002000000	60±120	Zinco Zinc Cinc	50	3600
C003000000	60±120	Rame Copper Cobre	50	3600
C004000000	60±120	Acciaio Inox Stainless steel Acero inoxidable	50	3600

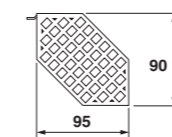

PARAFOGLIA ANGOLARE LEAF-GUARD FOR ANGULAR DRAIN PARAHOJAS ANGULAR

Codice Code Codigo	Tipo Type Tipo	Pz	Pz
C020000045	Per bocchettone angolare 45° For 45° angular drain Para cazoleta angular de 45°	20	1400



PAG. LISTINO
 PAGE LIST
 PÁG. LIST.
 29

PARAGHIAIA - PROLUNGA PER PARAGHIAIA ASTA UNIVERSALE



PAG. LISTINO
PAGE LIST
PÁG. LIST.

29

GRAVEL-GUARD - EXTENSION RING - UNIVERSAL ADAPTOR
PARAGRAVILLA - PROLONGACIÓN - ASTA UNIVERSAL

PARAGHIAIA GRAVEL-GUARD PARAGRAVILLA

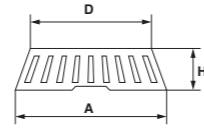

Codice Code Codigo	A	D	H	Pz	Pz
C023000000	195	170	50	50	1000

PROLUNGA EXTENSION RING PROLONGACIÓN

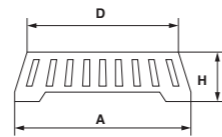

Codice Code Codigo	A	D	H	Pz	Pz
C024000000	215	195	170	50	1000

ASTA UNIVERSALE UNIVERSAL ADAPTOR ASTA UNIVERSAL

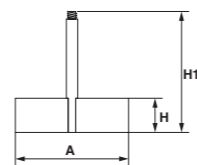

Codice Code Codigo	A	H	H1	Pz	Pz
C025000000	130	40	150	50	3500



PAG. LISTINO
PAGE LIST
PÁG. LIST.

30

PARAGHIAIA MODELLO SPAGNA GRAVEL-GUARD SPAIN VERSION PARAGRAVILLA MODELLO ESPAÑA

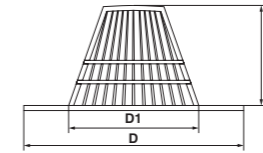

Codice Code Codigo	D	D1	H	Pz	Pz
C027000000	335	198	150	25	500

RETE PROTEGGI-GRONDE EAVES GUTTER-GUARD RED DE PROTECCIÓN DE CANALONES

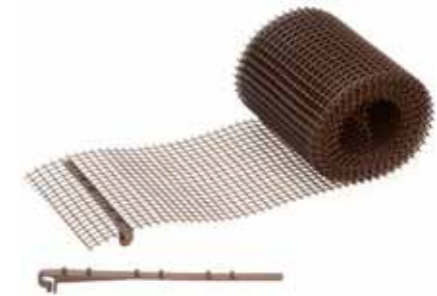
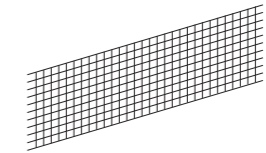

Codice Code Codigo	Misura Size Medida	Colore Colour Color	Pz	Pz
F128002618	mt 6 x cm 18	Marrone Brown Marrón	12	300
F128002624	mt 6 x cm 24	Marrone Brown Marrón	10	250

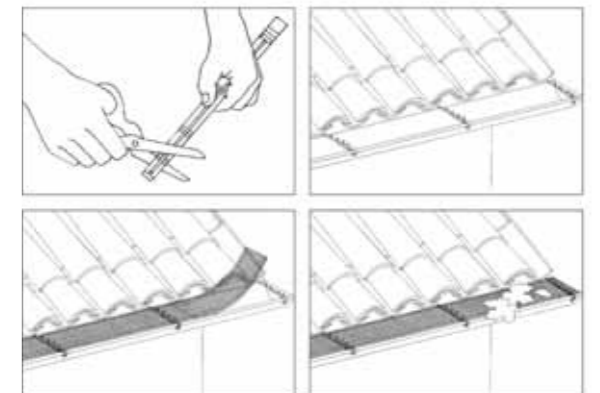

SALVASPORGENZE

PETTINI ANTINIDO

PAG. LISTINO
PAGE LIST
PÁG. LIST.

30

EAVE-COMB FILLER PARAGRAVAS

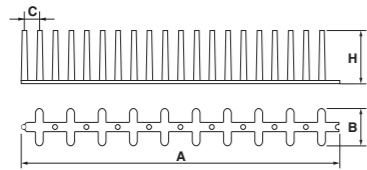

SALVASPORGENZE IN PP POLYPROPYLENE EAVE COMB FILLER PROTECTOR DE PAREDES DE PP

Codice Code Codigo	Tipo Type Tipo	A	B	C	H	Pz	Pz
F122008333	Neutro Neutral Neutro	500	55	25	80	100	800

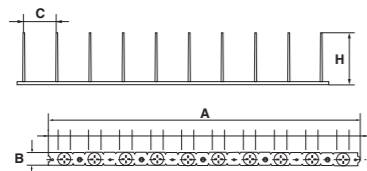

SALVASPORGENZE METALLICO STANDARD STANDARD METAL EAVE COMB FILLER PROTECTOR DE PAREDES METÁLICO ESTÁNDAR

Codice Code Codigo	A	B	C	H	Pz	Pz
F123011050	500	20	50	110	50	2000

SALVASPORGENZE METALLICO SPECIAL SPECIAL METAL EAVE COMB FILLER PROTECTOR DE PAREDES METÁLICO ESPECIAL

Codice Code Codigo	A	B	C	H	Pz	Pz
F124011050	500	20	50	110	25	1000

SALVASPORGENZE METALLICO INOX INOX METAL EAVE COMB FILLER PROTECTOR DE PAREDES METÁLICO

Codice Code Codigo	A	B	C	H	Pz	Pz
F125000000	1000	20	50	110	25	450

PP

INOX

PAG. LISTINO
PAGE LIST
PÁG. LIST.

31

ANTI-NEST COMB PEINES ANTINIDO

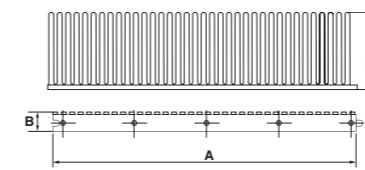

PETTINE ANTINIDO IN PP PP ANTI-NEST COMB PEINES ANTINIDO DE PP

Codice Code Codigo	Tipo Type Tipo	Colore Colour Color	A	B	H	Pz	Pz
F121010750	PP	Nero Black Negro	500	20	70	110	7200
F121010050	PP	Nero Black Negro	500	20	110	80	4800
F121011550	PP	Nero Black Negro	500	20	150	50	3000



PP

PETTINE ANTINIDO IN LAMIERA PREVERNICIATA ANTI-NEST COMB IN PRE-PAINTED SHEET METAL PEINE ANTINIDO DE CHAPA PREPINTADA

Codice Code Codigo	Tipo Type Tipo	Colore Colour Color	A	B	H	Pz	Pz
F121030050	Preverniciato Prepainted Prepintado	Testa di moro Dark brown Marrón oscuro	500	20	110	50	2000



INOX

PETTINE ANTINIDO IN RAME COPPER ANTI-NEST COMB PEINES ANTINIDO DE COBRE

Codice Code Codigo	Tipo Type Tipo	Colore Colour Color	A	B	H	Pz	Pz
F121020050	Rame Copper Cobre	Rame Copper Cobre	500	20	110	50	2000



CU



eternoivica

ETERNO IVICA SRL
Via Austria, 25/E - Z.I. SUD 35127 PADOVA - ITALY
T. ITALIA +39 049 8530101 T. EXPORT +39 049 8530102 FAX +39 049 8530111
eternoivica@eternoivica.com

www.eternoivica.com